

Canon
FAX-L250

User's Guide

Although this equipment can use either loop disconnect or DTMF signalling, only the performance of the DTMF signalling is subject to regulatory requirements for correct operation. It is therefore strongly recommended that the equipment is set to use DTMF signalling for access to public or private emergency services. DTMF signalling also provides faster call set up.

This CE Marking shows compliance of this equipment with Directive 73/23/EEC and Directive 89/336/EEC (as amended by Directive 92/31/EEC), both as amended by Directive 93/68/EEC.

Canon Inc. /Canon Europa N.V.

Copyright

Copyright © 1997 by Canon, Inc. All rights reserved. No part of this publication may be reproduced, transmitted, transcribed, stored in a retrieval system, or translated into any language or computer language in any form or by any means, electronic, mechanical, magnetic, optical, chemical, manual, or otherwise, without the prior written permission of Canon, Inc.

Trademarks

Canon® is a registered trademark, and UHQ™ is a trademark of Canon Inc. Other brand and product names may be trademarks or registered trademarks of their respective companies.



As an Energy Star Partner, Canon has determined that the FAX-L250 meets the Energy Star guidelines for energy efficiency.

NOTICE FOR CONNECTION TO TELECOMMUNICATION SYSTEMS IN THE UNITED KINGDOM AND THE REPUBLIC OF IRELAND

Approval Number XXXXXX (UK)

Your Canon FAX-L250 has been approved against the requirements of NTR3 for use in the UK and complies with the requirements of 91/263 EEC. The CE mark is applied in respect of the requirements of 72/23 EEC and 89/336 EEC. (UK)

It is intended for connection to analogue two wire public telecommunication networks.

 Connect the supplied cable to this socket first, then to the telephone line.

There are two auxiliary sockets to which equipment approved for direct connection to the network may be connected. If required, a suitable adaptor, approved under Approval Number NS/G/23/L/100005 for connections between the fax machine and any piece of approved telecommunications apparatus, is available from your Canon supplier. (UK)

 This socket is intended for connection of a telephone, the optional handset, an answering machine or similar device.

Voltage and current available at these sockets is determined by the network to which the line cable is connected. They will not normally exceed the limits for TNV as described in EN60950.

Canon recommend that any additional equipment connected in the installation is connected to one of these sockets. Do not connect additional equipment through parallel sockets elsewhere on the telephone line.

This equipment is not intended or recommended for making calls to emergency services.

EMC Directive

This equipment has been tested in a typical system to comply with the technical requirements of the EMC directive. Use of a shielded cable is necessary to comply with the technical requirements of the EMC Directive.

For your safety (Australia only)

To ensure safe operation the three-pin plug supplied must be inserted only into a standard three-pin power point which is effectively earthed through the normal household wiring.

Extension cords used with the equipment must be three-core and be correctly wired to provide connection to earth. Wrongly wired extension cords are a major cause of fatalities.

The power point shall be located near the equipment and shall be easily accessible.

The fact that the equipment operates satisfactorily does not imply that the power point is earthed and the installation is completely safe. For your safety, if in any doubt about the effective earthing of the power point, consult a qualified electrician.

Caution (New Zealand only)

1. This equipment may not necessarily provide for the effective hand-over of a call to or from a telephone connected to the same line.
2. The operation of this equipment on the same line as telephone or other equipment with audible warning devices or automatic ring detectors will give rise to bell tinkle or noise and may cause false tripping of the ring detector. Should such problems occur, the user is not to contact Telecom faults service.
3. Should this equipment become physically damaged, disconnect immediately from the Telecom connection and power source and contact your nearest service agent.

4. To relocate this equipment please.
 - 1) Disconnect the equipment from the Telecom connection.
 - 2) Disconnect the equipment from the power source.
 - 3) Reconnect the equipment to the power source.
 - 4) Reconnect the equipment to the Telecom connection.
5. If the supply cord of this equipment is damaged, it must be replaced by the special cord (Parts No.: HH2-1910).
6. Not all standard telephones will respond to incoming ringing when connected to the extension socket.

Safety Information

Laser Safety

Laser radiation could be hazardous to the human body. For this reason, laser radiation emitted inside this fax is hermetically sealed within the protective housing and external cover. In the normal operation of the product by the user, no radiation can leak from the machine.

This fax is classified as Class 1 laser product under IEC 825, and as for the USA, is classified as Class 1 under the Code of Federal Regulation, § 1040.10 of Title 21.



Use of controls, adjustments, or performance of procedures other than those specified in this user's guide may result in hazardous radiation exposure.

This label is attached to the laser scanner unit inside the FAX-L250 and is not in a user access area.

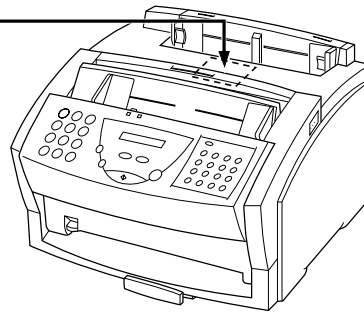



Contents

Chapter 1

INTRODUCING THE FAX-L250	1-1
Welcome	1-2
The Main Features of the FAX-L250	1-3
Plain Paper Fax Features	1-4
Copier Features	1-5
Telephone Features	1-5
How to Use this User's Guide	1-6
Type Conventions Used in this User's Guide	1-7
Customer Support	1-8
Safety Instructions	1-9

Chapter 2

SETTING UP YOUR FAX-L250	2-1
Choosing a Location for Your FAX-L250	2-3
Dimensions	2-4
Unpacking Your FAX-L250	2-5
Do You Have Everything?	2-5
Lifting the FAX-L250	2-7
Removing Shipping Materials	2-8
Replaceable Parts	2-10
Assembling the FAX-L250	2-11
Attaching Components	2-11
Attaching the Paper Rest	2-11
Attaching the Paper Loading Label	2-12
Attaching the Extension Tray	2-12
Attaching the Support Trays	2-13
Making Connections	2-14
Connecting the Telephone Line	2-14
Connecting the Optional Handset, a Telephone, or Answering Machine	2-15
Connecting the Power Cord	2-16
Getting Acquainted with Your FAX-L250	2-18
Front View	2-18
Inside View	2-19
Rear View	2-20
The Handset (Option)	2-20
The Operation Panel	2-21
Special Function Buttons	2-23



Contents

The Toner Cartridge	2-25
Handling and Storing Cartridges	2-25
Installing/Replacing the Toner Cartridge	2-27
Loading Recording Paper	2-33
Testing the FAX-L250	2-36
The Paper Path	2-37
Selecting Paper Delivery	2-38
Face-Down Delivery	2-39
Face-Up Delivery	2-40

Chapter 3

REGISTERING USER INFORMATION IN THE FAX-L250	3-1
Guidelines for Entering Information	3-2
Entering Numbers, Letters, and Symbols	3-3
Editing Information	3-5
Using the One-Touch Speed Dial/Special Function Buttons	3-6
Using the Menu System	3-6
Personalising Your FAX-L250	3-8
Identifying Your Documents	3-9
Entering the Date and Time	3-9
Registering Your Fax Number and Name	3-10
Setting the Telephone Line	3-12

Chapter 4

SPEED DIALLING	4-1
Speed Dialling Methods	4-2
One-Touch Speed Dialling	4-3
Storing Numbers for One-Touch Speed Dialling	4-3
Changing a Number/Name Stored under a One-Touch Speed Dialling Button	4-6
Using One-Touch Speed Dialling	4-9
Coded Speed Dialling	4-11
Storing Numbers for Coded Speed Dialling	4-11
Changing a Number/Name Stored under a Coded Speed Dialling Code	4-14
Using Coded Speed Dialling	4-17
Group Dialling	4-19
Creating Groups for Group Dialling	4-19
Using Group Dialling	4-22



Contents

Chapter 5

- SENDING FAXES 5-1**
- Preparing to Send a Fax 5-3**
 - Document Requirements 5-3
 - Scanning Area 5-5
 - Selecting Automatic/Manual Document Feed 5-6
 - Loading Documents for Automatic Feed 5-7
 - Loading Documents for Manual Feed 5-11
 - Setting the Resolution and Contrast 5-13
 - Setting the Scanning Resolution 5-13
 - Setting the Scanning Contrast 5-14
 - Sending Methods 5-15
 - Manual Sending via the Handset 5-15
 - Memory Sending 5-15
 - Dialling Methods 5-15
- Sending Documents 5-15**
 - Manual Sending via the Handset 5-16
 - Memory Sending 5-18
- Adding Pages to the Document in the Automatic Document Feeder (ADF) 5-20**
- Cancelling Sending 5-21**
 - Removing the Document from the Automatic Document Feeder (ADF) 5-22
- Redialling 5-24**
 - Manual Redialling 5-24
 - Automatic Redialling with Memory Sending 5-24
 - Cancelling Automatic Redialling 5-25
 - Setting Up Automatic Redialling 5-26
- Sequential Broadcasting 5-29**
 - Sending a Document to More than One Destination .. 5-29
 - Sending a Document Using Group Dialling 5-31
- Delayed Sending 5-32**
 - Sending Other Documents While the FAX-L250 is Set for Delayed Sending 5-34
- Documents Stored in Memory 5-35**
 - Printing a List of Documents Stored in Memory 5-37
 - Deleting a Document Stored in Memory 5-38
 - Resending a Document that Encountered an Error 5-38
- Sending with the Password/Subaddress Feature 5-40**
- If a Power Cut Occurs 5-43**



Contents

Chapter 6

RECEIVING FAXES	6-1
Different Ways to Receive a Fax	6-2
Setting the Receive Mode	6-3
Receiving Faxes and Phone Calls Automatically:	
Fax/Tel Mode	6-4
Setting Up Fax/Tel Mode	6-4
What Happens When Fax/Tel Mode is Selected ...	6-6
Receiving Faxes Manually: MANUAL MODE	6-9
Receiving Faxes Automatically: FAX ONLY MODE	6-10
Using an Answering Machine: ANS.MACHINE	
MODE	6-11
Using the FAX-L250 with an Answering Machine ..	6-11
Network FAX/TEL Switching (Australia Only)	6-12
Setting the FAX-L250 for Network Switch	6-12
Network Switch System Operation	6-13
Network FAX/TEL Switching (New Zealand Only)	6-14
Setting the FAX-L250 for Network Switch	6-14
Network Switch System Operation	6-15
Documents Received in Memory	6-16
Messages Displayed When Documents are Received	
in Memory	6-16
Printing Documents Received in Memory	6-17
Receiving while Registering, Copying, or Printing	6-17
Cancelling an Incoming Fax	6-18
Polling to Receive Faxes	6-19
Polling a Fax Machine	6-19

Chapter 7

SPECIAL FEATURES	7-1
Special Dialling	7-2
Dialling Through a Switchboard	7-2
Registering the Access Type and Outside Line	
Access Number under the R Button	7-2
Long Distance Dialling	7-4
How to Enter Pauses	7-4
Confirming a Dial Tone	7-5
Using Tone Dialling on a Pulse Line	7-6
Restricting Use of the FAX-L250	7-7
Using Alternative Telephone Networks (UK	
Only)	7-9
Attaching the M Label	7-9
Registering an Alternative Telephone Network	7-10
Sending with an Alternative Telephone Network	7-12
Registering Speed Dialling with the M Button	7-13



Contents

Chapter 8	MAKING COPIES	8-1
	Making Copies	8-2
Chapter 9	REPORTS AND LISTS	9-1
	Activity Report	9-2
	Transmission (TX) Reports	9-3
	Error TX Report	9-3
	TX Report	9-4
	Multi TX/RX Report	9-5
	Reception (RX) Report	9-6
	Memory Clear Report	9-7
	User's Data List	9-8
	Speed Dialling Lists	9-10
	One-Touch Speed Dial List	9-11
	Coded Speed Dial List	9-11
	Group Dial List	9-11
Chapter 10	FREQUENTLY ASKED QUESTIONS	10-1
	If You Cannot Solve the Problem	10-2
	Problems Index	10-3
	Paper Jams	10-5
	Jams in the Automatic Document Feeder (ADF)? ..	10-5
	Jams in the Output Slots?	10-8
	Jams Inside the Unit?	10-9
	Jams in the Front Area of the Unit?	10-14
	After Clearing a Paper Jam	10-17
	Problems Feeding Paper Into the FAX-L250 Sheet	
	Feeder	10-18
	Faxing Problems	10-20
	Sending Faxes	10-20
	Receiving Faxes	10-22
	Telephone Problems	10-26
	Copying Problems	10-26
	Printing Problems	10-27
	Print Quality Problems	10-28
	General Problems	10-29
	Error Codes, Messages, and Solutions	10-30



Contents

Chapter 11	MAINTAINING YOUR FAX-L250 11-1
	Cleaning the FAX-L250 11-2
	Cleaning the FAX-L250 Exterior 11-2
	Cleaning the Inside of the FAX-L250 11-3
	Replacing the Toner Cartridge 11-8
	Transporting the FAX-L250 11-9
Chapter 12	THE MENU SYSTEM 12-1
	Understanding the Menu System 12-2
	Accessing the TEL REGISTRATION Menu 12-2
	Accessing the USER SETTINGS Menu 12-4
	Accessing the REPORT SETTINGS Menu 12-6
	Accessing the TX SETTINGS Menu 12-8
	Accessing the RX SETTINGS Menu 12-10
	Accessing the FAX PRINTER Menu 12-12
	Accessing the SYSTEM SETTINGS Menu 12-14
Appendix A	SPECIFICATIONS A-1
	General A-2
	Plain Paper Fax A-4
	Copier A-6
	Telephone A-6
	Document Sizes A-7
	Printing Area A-8
Appendix B	OPTIONS B-1
	Optional Handset B-2
	Package Contents B-2
	Attaching the Handset to Your Unit B-3
	Control Panel and Functions B-6
	Maintaining Your Handset B-8
Glossary G-1
Index I-1

This page is intentionally blank.

1

Introducing the FAX-L250

This chapter introduces you to the main features of the FAX-L250. It also explains how to get the most out of the documentation that comes with the unit, and gives important safety instructions.

Welcome	1-2
The Main Features of the FAX-L250	1-3
Plain Paper Fax Features	1-4
Copier Features	1-5
Telephone Features	1-5
How to Use this User's Guide	1-6
Type Conventions Used in this User's Guide	1-7
Customer Support	1-8
Safety Instructions	1-9

Welcome

Thank you for purchasing the new Canon FAX-L250. The FAX-L250 is a G3 facsimile unit that allows you to send documents at high speed, in the shortest time possible. We are sure that your FAX-L250 will help meet your fax and phone requirements easily and conveniently, as well as your copying needs.

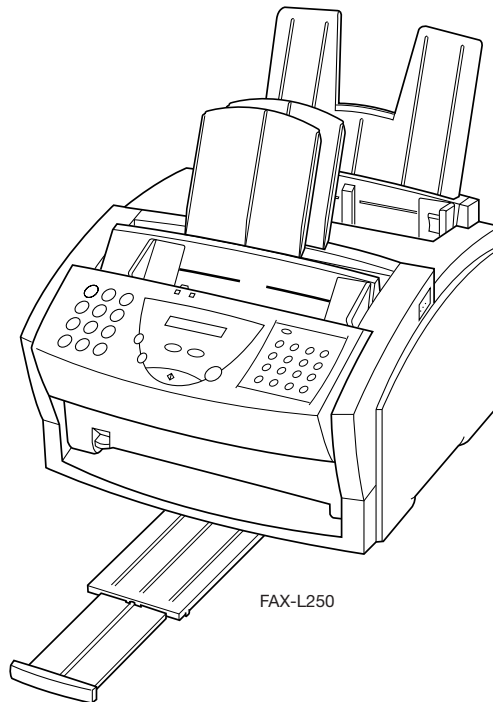



The Main Features of the FAX-L250

1



The FAX-L250 is a multifunction system for your home or small office. The FAX-L250 combines a plain paper fax machine, a copier, and a telephone* into a single, convenient desktop unit.

The FAX-L250's multitasking ability enables you to perform operations simultaneously. For example, you can make copies at the same time you are sending a fax or receiving a fax into memory.

The compact size of the FAX-L250 makes it ideal for desktop use, and lets you use it in places where other machines may not fit.

The FAX-L250 includes the following features:

Excellent print quality and speed

The FAX-L250 offers 600 × 600 dpi laser beam printing, providing you with high resolution text and graphics. The exceptional printing speed of 6 pages per minute allows you to work more effectively.

Simple maintenance

The FX-3 toner cartridge for the FAX-L250 contains both the toner and the drum, making installation and replacement simple.

Convenient paper handling

The FAX-L250 sheet feeder holds up to 100 sheets** of plain A4, letter, or legal-size paper.

Economy toner-saving printing

The FAX-L250 includes an economy printing mode that uses up to approximately 50% less toner, resulting in longer cartridge life.

Flexible document feeding

The FAX-L250 includes an Automatic Document Feeder (ADF) that can be set for automatic document feed or manual document feed, according to your needs. This allows you to fax a variety of documents, from multipage documents (up to 20 A4- or letter-size pages, or 10 legal-size pages at a time), to a single photo or business card.

* Requires the optional handset, a telephone, or an answering machine.

** 75 g/m² paper

Plain Paper Fax Features

UHQ™ Image Processing System

The FAX-L250 uses Canon's Ultra-High Quality Image Processing System to provide enhanced definition in faxed photos.

Error Correction Mode (ECM)

Using the FAX-L250's Error Correction Mode reduces transmission errors when sending faxes to or receiving faxes from other fax machines that also have ECM capability.

Automatic switching between fax and voice calls

The FAX-L250 can automatically distinguish between fax calls and normal telephone calls, so that you can receive both through a single phone line.

Answering machine connection

You can connect an answering machine to the FAX-L250 to let it receive telephone messages and faxes while you are away from your desk.

Transmission speed

The FAX-L250 uses G3 data encoding methods that increase transmission speed to approximately 6 seconds* per page.

Memory sending/receiving

The FAX-L250 can store up to 90* fax pages (either received or to be sent) in its built-in memory, and can receive faxes while printing.

Reduced-size printing

The FAX-L250 automatically scales received faxes to fit the size of the paper loaded into the sheet feeder. So if your client is sending you a fax on paper larger than an A4-size page and you have A4-size paper in your sheet feeder, the fax will be scaled and printed on A4-size paper.

Automatic dialling and broadcasting

To make faxing even easier, the FAX-L250 provides several automatic dialling methods: coded speed dialling, one-touch speed dialling, and group dialling. The FAX-L250 also enables you to broadcast faxes or send faxes at a preset time to as many as 117 locations at once.

* Based on Canon FAX Standard Chart No.1, standard mode

Copier Features

1

Up to 99 copies

The FAX-L250 can make up to 99 copies of a document at a time, at a rate of up to six copies per minute.

600 dpi and 300 dpi resolution

The FAX-L250 copies documents at 600×300 dpi when using direct copying, and 300×300 dpi when using memory copying.

Copy reduction

The FAX-L250 can reduce copies to 90%, 80%, or 70% of their original size. This allows you to copy legal-size documents onto A4-size paper, for example.

Telephone Features

Automatic dialling

The FAX-L250's three automatic dialling methods (one-touch speed dialling, coded speed dialling, and group dialling) can be used to store phone numbers and fax numbers for easy and efficient calling.

Connection for the optional handset, an answering machine or a telephone

Connecting the optional handset or a telephone to the FAX-L250 allows you to use it to make and receive normal telephone calls. In addition, connecting an answering machine allows you to receive faxes and phone messages while you are away from your desk.



How to Use this User's Guide

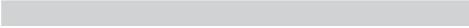

To make the best use of this user's guide in learning how to set up and operate your FAX-L250, be sure to do the following:

- Read this chapter to learn about the FAX-L250's main features and for guidelines on using the unit safely.
- Carefully follow the instructions in Chapter 2, "Setting Up Your FAX-L250" to get your unit unpacked and assembled properly.
- Read Chapter 3 to learn how to enter information in the FAX-L250 and to register your user information.
- Read Chapters 4 through 9 to master the FAX-L250 operating procedures (such as sending faxes, receiving faxes and making copies) and to learn more about its special features (such as restricting use of the unit and special dialling features).
- If your FAX-L250 begins operating improperly, use Chapter 10, "Frequently Asked Questions," to try to solve the problem.
- Look over Chapter 11, "Maintaining Your FAX-L250" to become familiar with procedures for cleaning your FAX-L250 and replacing the toner cartridge.
- Refer to Chapter 12 "The Menu System" to learn how to change settings of the FAX-L250.
- Refer to Appendix A for the FAX-L250 technical specifications.
- Refer to Appendix B if you have purchased the optional handset.

If you still have questions about how to use your FAX-L250, please contact your local authorised Canon dealer or service representatives. They will be happy to answer your questions.

Type Conventions Used in this User's Guide

1

This user's guide follows the conventions below to emphasise certain information that will help you use your FAX-L250 correctly and safely:



Cautions tell you how to avoid actions that could injure you or damage your FAX-L250.



Notes provide advice for using your FAX-L250 more effectively, describe operating restrictions, and tell how to avoid minor operating difficulties.

In addition, this user's guide uses bold capital letters to show the names of buttons and switches on the FAX-L250, such as **FUNCTION**, **STOP**, and **START/COPY**. Text that appears in the unit's display is shown in plain capital letters, such as: **RECEPTION OK**.



Customer Support



Your FAX-L250 is designed with the latest technology to provide trouble-free operation.

If you have a problem with the unit's operation, try to solve it by using the information in Chapter 10, "Frequently Asked Questions". If you cannot solve the problem or if you think your FAX-L250 needs service, contact your local authorised Canon dealer or service centre.

Safety Instructions

1

Read these safety instructions thoroughly before using your FAX-L250, and keep them handy in case you need to refer to them later.



Except as specifically described in this user's guide, do not attempt to service the FAX-L250 yourself. Never attempt to disassemble the unit: opening and removing its interior covers will expose you to dangerous voltages and other risks. For all service, contact your local authorised Canon dealer or service centre.

- Always follow all warnings and instructions marked on the FAX-L250.
- Use the FAX-L250 only on a sturdy, stable, level surface. If the unit falls, it could be seriously damaged.
- Do not use the FAX-L250 near water. If you spill liquid on or into the unit, unplug it immediately and call your local authorised Canon dealer or service centre.
- The back of the FAX-L250 includes slots and openings for ventilation. To keep the FAX-L250 from overheating (which can cause it to operate abnormally and create a fire risk), take care not to block or cover these openings. Do not operate the unit on a bed, sofa, rug, or other similar soft surface, or near a radiator or other heat source. Do not place the FAX-L250 in a cupboard or cabinet or on shelves unless adequate ventilation is available. See "Choosing a Location for Your FAX-L250" on page 2-3 for guidelines on how much space the unit needs for ventilation.
- Operate the FAX-L250 only from the type of power source indicated on the unit's label. If you are unsure of the type of power available from your wall outlets, contact your local power company.
- Make sure the total amperage used by all devices plugged into the wall outlet does not exceed the ampere rating of the outlet's circuit breaker.
- Do not allow anything to rest on the power cord or place the FAX-L250 where the cord will be walked on. Make sure the cord is not knotted or kinked.

Introducing the FAX-L250

- Do not insert objects of any kind into the slots or openings on the FAX-L250's cabinet, as they could touch dangerous voltage points or short out parts, and result in fire or electric shock.
- Do not allow small objects (such as pins, paper clips, or staples) to fall into the FAX-L250. If something does fall into it, unplug the unit immediately and call your local authorised Canon dealer or service centre.
- Do not plug the power cord into an uninterruptible power supply (UPS).
- Always unplug the FAX-L250 before moving or cleaning it.
- Whenever you unplug the FAX-L250, wait at least five seconds before you plug it back in.
- Keep the FAX-L250 away from direct sunlight, as this can damage it. If you have to place it near a window, install heavy curtains or blinds.
- Do not expose the FAX-L250 to extreme temperature fluctuations. Install the unit in a place with temperatures between 10° and 32.5°C.
- Always unplug the FAX-L250 during thunderstorms.
- Before you transport the FAX-L250, remove the toner cartridge.
- Always lift the FAX-L250 as shown below. Never lift it by its sheet feeder or other supports.

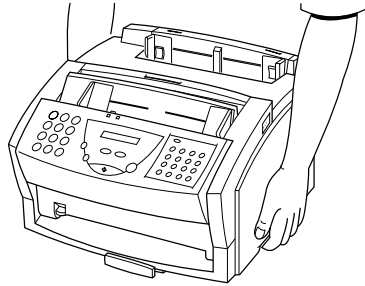



Unplug the FAX-L250 and contact your local authorised Canon dealer or service centre in any of these situations:

- If the power cord or plug is damaged or frayed.
- If liquid spills into the unit, or if it is otherwise exposed to rain or liquids.
- If you notice smoke or unusual noises or odour coming from it.
- If the FAX-L250 does not operate normally when you follow the operating instructions. Adjust only those controls that are covered by the operating instructions in this user's guide, or you can damage the unit and require extensive repair work.
- If the FAX-L250 is dropped or its cabinet damaged.
- If the FAX-L250 begins performing poorly, and you cannot correct the problem by following the procedures in Chapter 10, "Frequently Asked Questions".

This page is intentionally blank.

2

Setting Up Your FAX-L250

This chapter tells you how to unpack, assemble, and connect your FAX-L250, install the FX-3 toner cartridge, and load paper – everything you need to know to get your FAX-L250 ready to use.

Choosing a Location for Your FAX-L250	2-3
Dimensions	2-4
Unpacking Your FAX-L250	2-5
Do You Have Everything?	2-5
Lifting the FAX-L250	2-7
Removing Shipping Materials	2-8
Replaceable Parts	2-10
Assembling the FAX-L250	2-11
Attaching Components	2-11
Attaching the Paper Rest	2-11
Attaching the Paper Loading Label	2-12
Attaching the Extension Tray	2-12
Attaching the Support Trays	2-13
Making Connections	2-14
Connecting the Telephone Line	2-14
Connecting the Optional Handset, a Telephone, or Answering Machine	2-15
Connecting the Power Cord	2-16
Getting Acquainted with Your FAX-L250	2-18
Front View	2-18
Inside View	2-19
Rear View	2-20
The Handset (Option)	2-20
The Operation Panel	2-21
Special Function Buttons	2-23
The Toner Cartridge	2-25
Handling and Storing Cartridges	2-25
Installing/Replacing the Toner Cartridge	2-27

Loading Recording Paper	2-33
Testing the FAX-L250	2-36
The Paper Path	2-37
Selecting Paper Delivery	2-38
Face-Down Delivery	2-39
Face-Up Delivery	2-40



Choosing a Location for Your FAX-L250



Before unpacking your FAX-L250, follow these guidelines to choose an appropriate location for the unit.

2



Please review the information provided in "Safety Instructions" on page 1-9, to make sure you are installing your FAX-L250 for safe use.

- Put the FAX-L250 in a cool, dry, clean, well ventilated place:
 - Make sure the area is free from dust.
 - Make sure the location is not affected by extreme temperature fluctuations, and remains between 10° and 32.5°C.
 - Make sure the area's relative humidity is always between 20% and 85%.
- Keep the FAX-L250 away from direct sunlight.
- If possible, place the FAX-L250 near an existing telephone outlet, to allow for an easy connection of the telephone line to the unit.
- Place the FAX-L250 near an electrical wall outlet that provides 200–240-volt AC (50–60 Hz) power.
- Do not plug the FAX-L250 into the same circuit as an appliance such as an air conditioner, electric typewriter, television, or copier. Such devices generate electrical noise that can interfere with your unit's ability to send or receive faxes.
- Set the FAX-L250 on a flat, stable, vibration-free surface that is strong enough to support its weight (about 8.6 kg).

Dimensions

Make sure the location you choose provides enough space around the FAX-L250 for adequate ventilation, and to allow paper to flow freely into and out of the unit. The figure below shows the minimum space required for the unit.

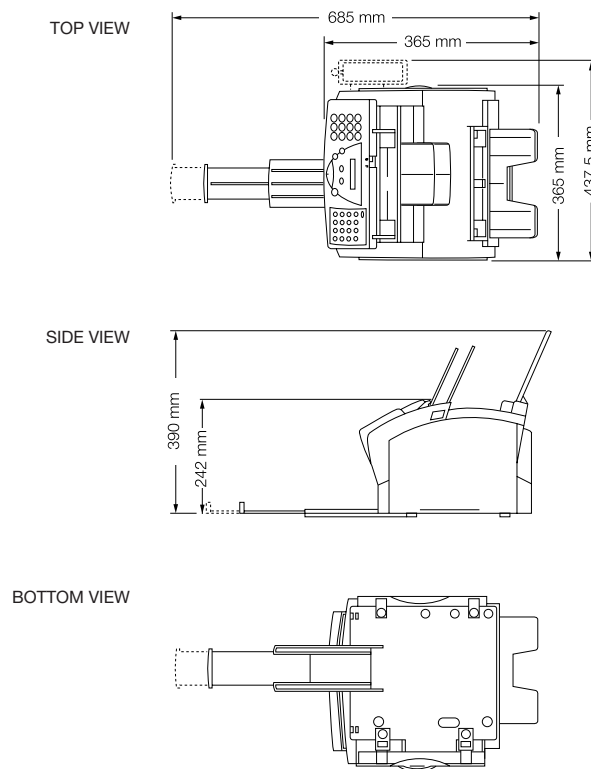

If you need help installing your FAX-L250 or have any questions about it, please contact your local authorised Canon dealer or service centre.

Unpacking Your FAX-L250

Follow the directions below to unpack your FAX-L250 properly, and to make sure you have all of its components and documentation.

Do You Have Everything?

2

As you unpack the FAX-L250, save the carton and packing material in case you want to move or ship the unit in the future.

- 1** Carefully remove all items from the box. You should have someone help by holding the box while you lift the FAX-L250 and its protective packaging out of the carton.

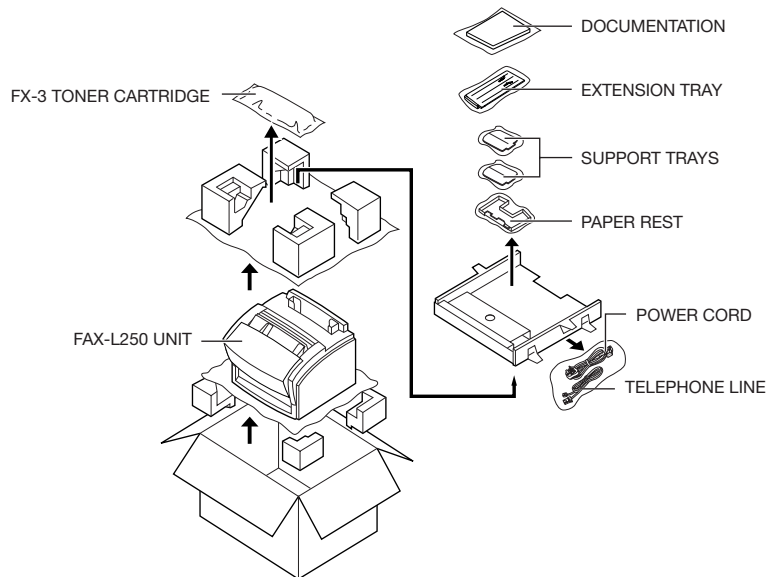

2 Make sure you have the following items:

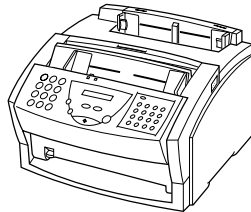

FAX-L250 UNIT

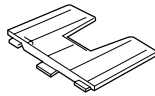

PAPER REST

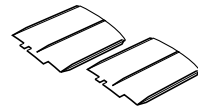

SUPPORT TRAYS

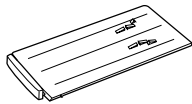

EXTENSION TRAY



POWER CORD*

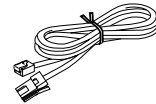

TELEPHONE LINE**

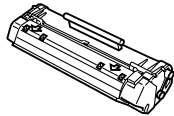

FX-3 TONER CARTRIDGE



FAX- L250 USER'S GUIDE
(This book)



PAPER LOADING LABEL



M LABEL (UK Only)

If any of the above items are damaged or missing, notify your Canon dealer immediately.

* The shape of the power cord varies depending on the country of purchase.

** The shape of the telephone line varies depending on the country of purchase.

Lifting the FAX-L250

Whenever you plan to move the FAX-L250, be sure to:

- Hold the unit firmly and keep it level.
- Always grip the sides of the unit. The recessed areas on each side of the unit serve as handles.

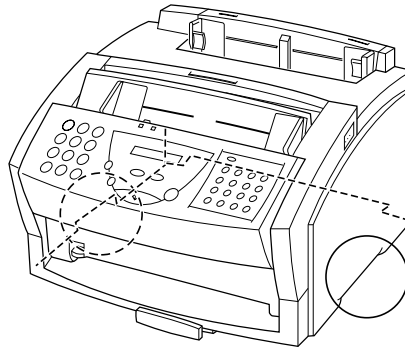

2

Removing Shipping Materials

In order to protect your FAX-L250 during shipping, the unit has been packed with protective material that you must remove before using. Follow these steps:

- 1** Remove all pieces of shipping tape from the outside of the FAX-L250.

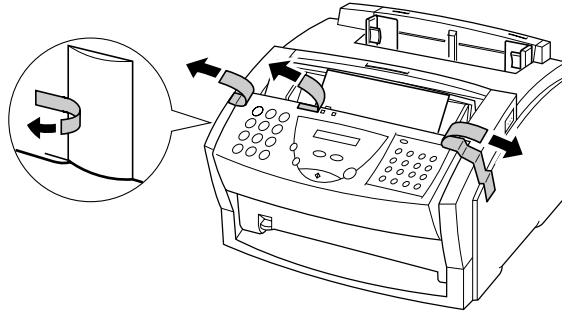

- 2** Open the operation panel by grasping it with both hands and gently pulling it towards you.

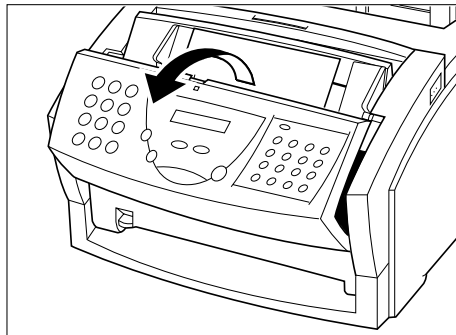

- 3** Remove the soft styrofoam sheet from the Automatic Document Feeder (ADF), then gently close the operation panel by pressing it down from the centre until it clicks.

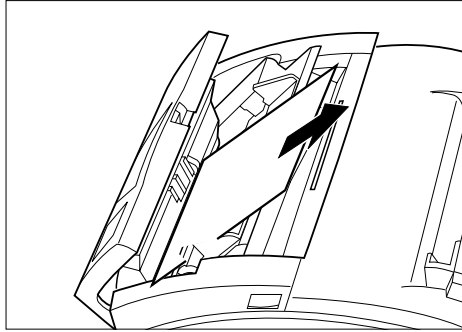

2

- 4** Peel the clear protective sheet off the LCD display.

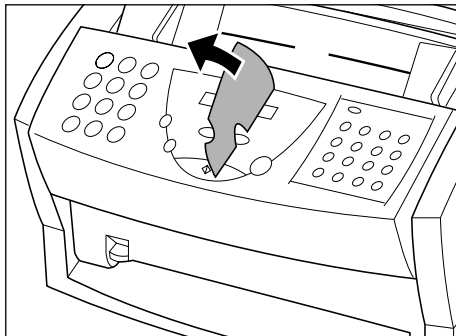

Replaceable Parts

The only component of the FAX-L250 that needs regular service or replacement is the FX-3 toner cartridge. Although Canon manufactures many types of toner cartridges, the FX-3 toner cartridge is the only one designed to be used with your FAX-L250. The FX-3 toner cartridge can be purchased at any Canon authorised dealer.

Assembling the FAX-L250

Use the following instructions to assemble your FAX-L250 main unit and components. To see how the FAX-L250 will look fully assembled, see "Getting Acquainted with Your FAX-L250" on page 2-18.

Attaching Components

2

■ Attaching the Paper Rest

The paper rest helps keep paper or other media straight in the sheet feeder.

To attach the paper rest, insert the two side tabs diagonally into the corresponding slots above the sheet feeder, and then straighten it.

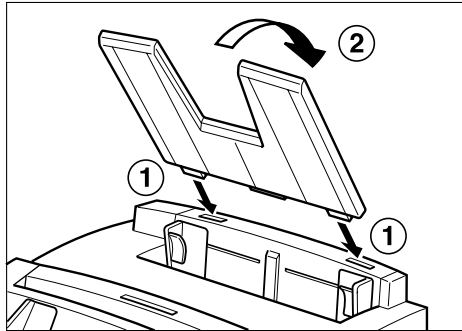

Setting Up Your FAX-L250

■ Attaching the Paper Loading Label

The paper loading label is included with your FAX-L250 unit.

Attach the label to the left of the sheet feeder as shown below.

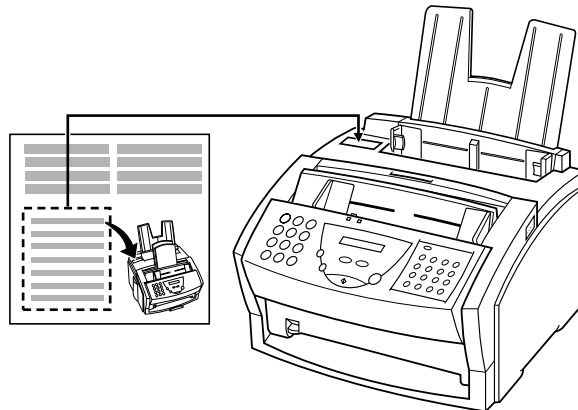

■ Attaching the Extension Tray

Lift the FAX-L250 unit as shown and slide the extension tray into the rails on the bottom of the unit.

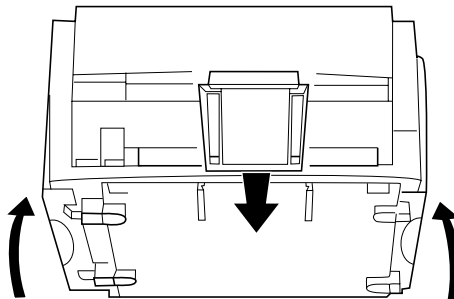

■ Attaching the Support Trays

There are two identical support trays. One of the support trays holds paper as it comes out of the face-down delivery slot. To install this support, insert the tabs into the corresponding slots above the face-down delivery slot, making sure that the smaller tab is on the left.

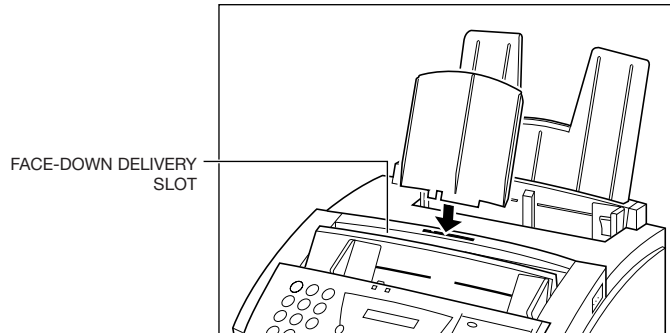

2

The other support tray holds documents as they are fed into the Automatic Document Feeder (ADF). To install this support, insert the tabs into the corresponding slots above the Automatic Document Feeder (ADF), making sure that the smaller tab is on the left.

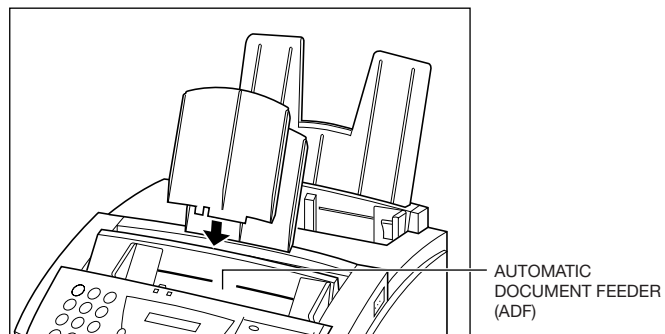

Making Connections

Connecting the Telephone Line

Connect the FAX-L250 to a telephone line as follows:

- 1** Connect one end of the supplied telephone line to the jack marked  on the back of the FAX-L250.

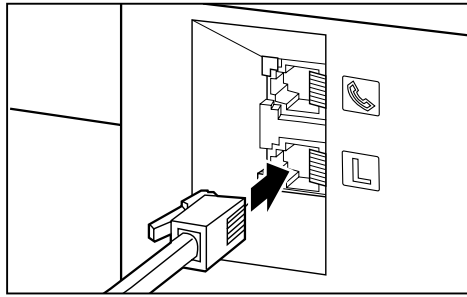

- 2** Connect the other end of the line to your wall telephone jack.

Connecting the Optional Handset, a Telephone, or Answering Machine

To use your FAX-L250 to make or receive normal telephone calls, you must connect the optional handset or a telephone. You can also attach an answering machine (with or without a telephone).

Connect the line from the optional handset, telephone or answering machine to the jack marked  on the back of the FAX-L250.

2

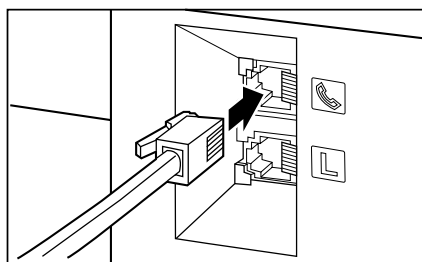

If you connect an answering machine to the FAX-L250, be sure to read "Using an Answering Machine: ANS.MACHINE MODE" on page 6-11.

■ Users in the UK Only

To connect a telephone or answering machine to the FAX-L250, you may need to connect the optional B.T. adaptor. Contact your Canon supplier for more information.

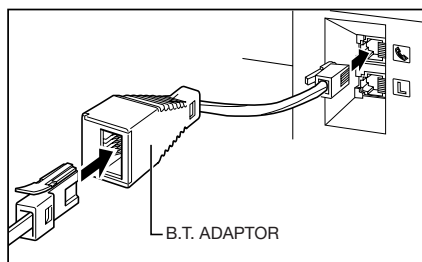

Connecting the Power Cord



Follow these guidelines when connecting your FAX-L250 to a power source:

- The FAX-L250 is intended for domestic use only and requires 200–240 V AC. Do not use it outside the country where it was purchased.
- Use only the power cord that came with the unit. Using a longer cord or extension cord can cause the FAX-L250 to malfunction.
- Unplug the unit only by pulling on the plug itself. Never pull on the cord.
- Do not plug the FAX-L250 into an outlet shared with an appliance such as an air conditioner, computer, electric typewriter, or copier. These devices generate electrical noise, which can interfere with the operation of the FAX-L250.
- Make sure nothing is laying on the power cord, and that the cord cannot be walked on or tripped over.
- Do not overload the electrical outlet. Make sure the total amperage used by all the machines plugged into the outlet does not exceed the ampere rating of the outlet's circuit breaker.
- Do not plug the unit into an uninterruptible power supply (UPS).

Connect the power cord as follows:

- 1** Plug the supplied power cord into the power connector on the back of the FAX-L250.

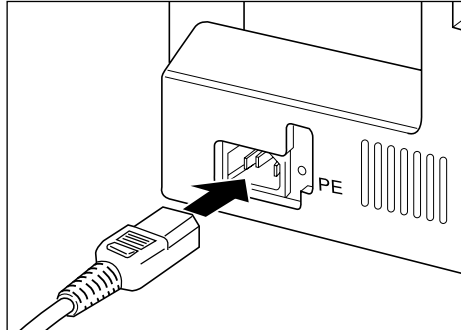

2 Plug the other end of the power cord into the outlet.



The FAX-L250 has no power switch, so its power is on as long as it is plugged in. Once connected, though, the unit still needs to warm up before you can use it.

- While the FAX-L250 is warming up, the message PLEASE WAIT appears in the LCD display:
- When the time and receive mode appear, the FAX-L250 is in standby mode and ready for use:

PLEASE WAIT

13:00 FaxOnly

2



If the toner cartridge has not been installed yet, the message CHECK COVER/CART alternates with the standby mode display:

CHECK COVER/CART

13:00 FaxOnly

Getting Acquainted with Your FAX-L250

Before using your FAX-L250, look over the diagrams on these pages to become familiar with the unit's components and their functions.

Front View

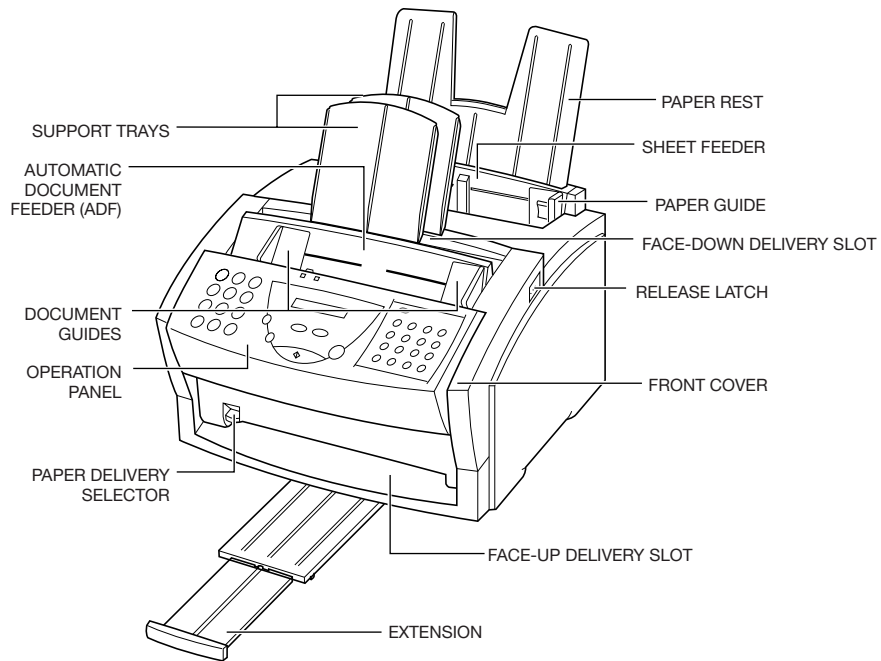

Inside View

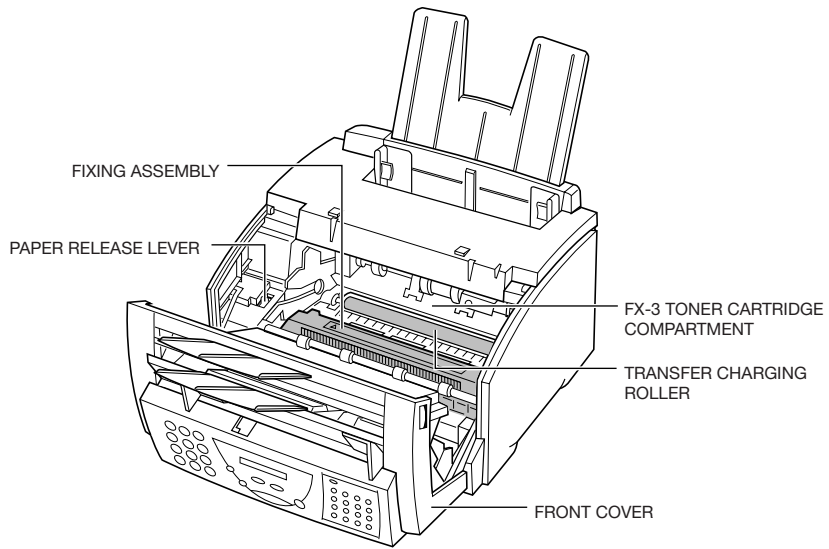

2

Rear View

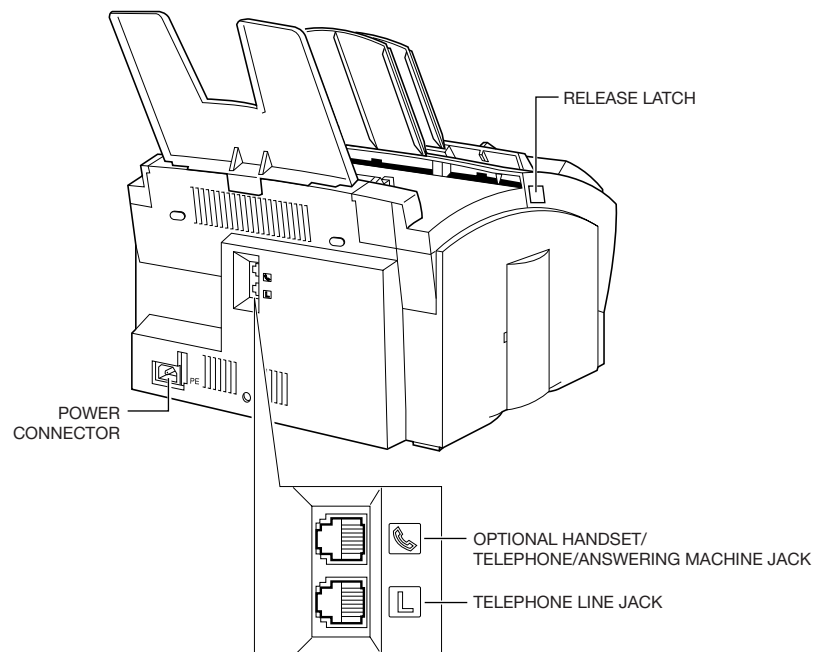

The Handset (Option)

For details on the optional handset, see Appendix B.

The Operation Panel

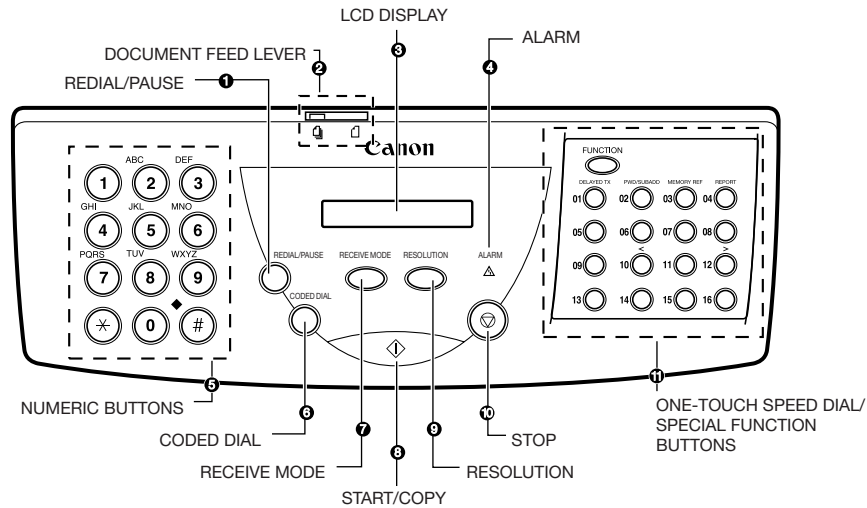



2

1 REDIAL/PAUSE button

Press this button to redial the last number that was dialed using the numeric buttons, or to enter pauses between digits when dialling or registering fax numbers.

2 Document feed lever

Set this lever to the left () for automatic document feed, or to the right () for manual document feed.

3 LCD display

The LCD display shows messages and prompts during operation, and displays selections, text, numbers and names when registering information.

4 ALARM lamp

This lamp flashes when an error occurs, or when the FAX-L250 is out of paper or toner.

Setting Up Your FAX-L250

⑤ **Numeric buttons**

Use these buttons to enter numbers and names when registering information, and to dial fax/telephone numbers that are not registered for automatic dialling.

⑥ **CODED DIAL button**

Press this button and a two-digit code to dial a fax/telephone number that you have registered for coded speed dialling.

⑦ **RECEIVE MODE button**

Use this button to select whether the FAX-L250 is set to receive faxes manually (**MANUAL MODE**), to treat all calls as faxes (**FAX ONLY MODE**), to use an answering machine to receive all calls (**ANS.MACHINE MODE**), or to automatically switch between telephone and fax receiving, depending on the type of call (Fax/Tel Mode).

⑧ **◀▶ (START/COPY) button**

Press this button to begin sending, receiving, scanning, copying or other operations, or to select functions when registering information.

⑨ **RESOLUTION button**

Press this button to select the resolution the FAX-L250 will use for the document you want to fax or scan.

⑩ **⏏ (STOP) button**

Press this button to cancel sending, receiving, or any other operation.

⑪ **One-Touch Speed Dial/Special Function buttons**

Use these buttons for one-touch speed dialling and to perform special operations. See pages 2-23 and 2-24 for details on the special function buttons.

■ Special Function Buttons

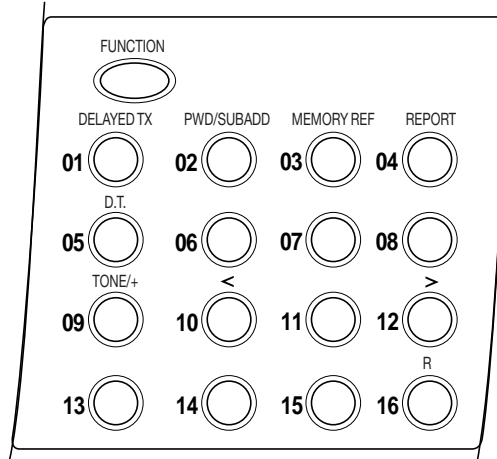

2

■ FUNCTION button

Use this button to enable access to the special function buttons described below.

■ DELAYED TX button 01

Press this button to register a time for delayed sending.

■ PWD/SUBADD button 02

Press this button to send a document using a password and subaddress based on the ITU-T standard.

■ MEMORY REF button 03

Use this button to delete or resend documents stored in memory, or to print a list of documents in memory.

■ REPORT button 04

Use this button to print activity reports.

Setting Up Your FAX-L250

■ **D.T. button 05**

Press this button to confirm the dial tone when dialling a number. (Not used in the UK, Hong Kong, Australia, New Zealand, Singapore, or Malaysia.)

■ **TONE/+ button 09**

Press this button to use tone dialling temporarily when your unit is set for pulse dialling. Press also to enter a + sign when registering your fax/telephone number.

■ **<, > (Arrow) buttons 10 and 12**

Use these buttons to scroll through menu selections or to move the cursor when registering data.

■ **R button 16**

Press this button to dial an outside line access number when the unit is connected through a switchboard (PBX).

The Toner Cartridge

Handling and Storing Cartridges

2

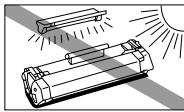

- Do not expose the cartridge to direct sunlight or bright light for longer than five minutes.

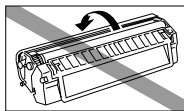

- Do not open the drum protective shutter on the cartridge. If the drum surface is exposed to light and damaged, print quality may deteriorate.

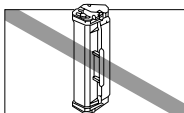

- Do not stand the cartridge on end, and do not turn it upside down. If toner becomes caked in the cartridge, it may prove impossible to free it even by shaking the cartridge.

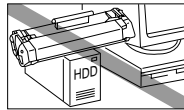

- Keep the cartridge away from computer screens, disc drives, and floppy discs. The magnet inside the cartridge may harm these items.

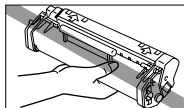

- Never touch the drum protective shutter. When holding the cartridge avoid touching the drum protective shutter with your hands.

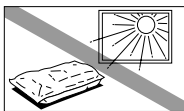

- Do not store the cartridge in direct sunlight.

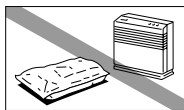

- Avoid locations subject to high temperature, high humidity, or rapid changes in temperature. Store the cartridge between 0° and 35°C.

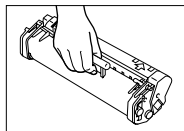

- Hold the cartridge as shown so that your hand is not touching the drum protective shutter.

Setting Up Your FAX-L250

- Store the cartridge in its protective bag. Do not open the bag until you are ready to install the cartridge in the unit.
- Save the protective bag. You may need to repack and transport the cartridge at a later date.
- Do not store the cartridge in salty air or where there are corrosive gases such as from aerosol sprays.
- Do not remove the cartridge from the FAX-L250 unless necessary.



DO NOT PLACE THE CARTRIDGE IN FIRE. TONER POWDER IS FLAMMABLE.

Installing/Replacing the Toner Cartridge

The FAX-L250 uses a Canon FX-3 toner cartridge. The procedure below explains how to install the cartridge for the first time, and how to replace it when the toner runs out.

When the message **CHANGE CARTRIDGE** appears, the toner in the cartridge may simply be unevenly distributed. Before replacing the cartridge, follow the instructions on page 10-28 to evenly distribute the toner. If after doing this the message remains displayed or the print quality is low, replace the cartridge as described below.

2



Canon makes numerous cartridges. The FX-3 toner cartridge has been designed specially for the FAX-L250 and is the only one Canon recommends that you use.

- 1** Remove any documents and/or printed pages from the unit.
- 2** Make sure the FAX-L250 is plugged in.
- 3** Open the front cover by pressing the release latches on the sides of the unit.
 - Lift the cover forward to its open position.

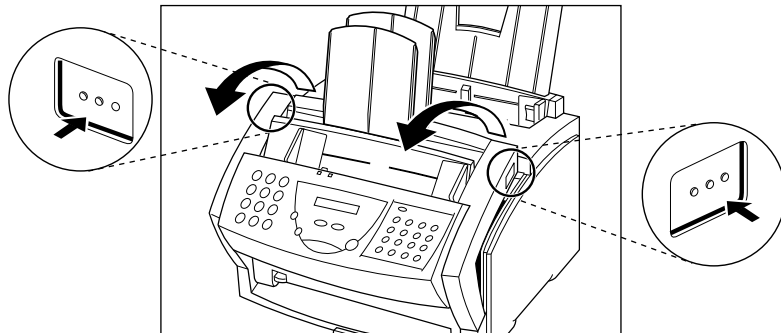

Setting Up Your FAX-L250



Do not open the front cover without pressing the release latches as this may cause damage to your unit.

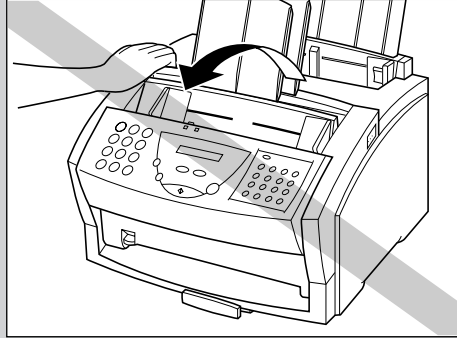

4 If replacing a used cartridge, hold the cartridge by its handle and remove it as shown.

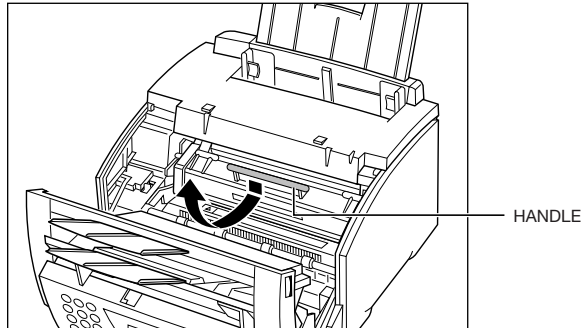

5 Remove the new FX-3 toner cartridge from its protective bag.

- Save the protective bag the cartridge comes in. You may need to repack the cartridge later.

6 Gently rock the cartridge from side to side several times to distribute the toner evenly inside the cartridge.

- Poor print quality may result if the toner becomes unequally distributed inside the cartridge.

2

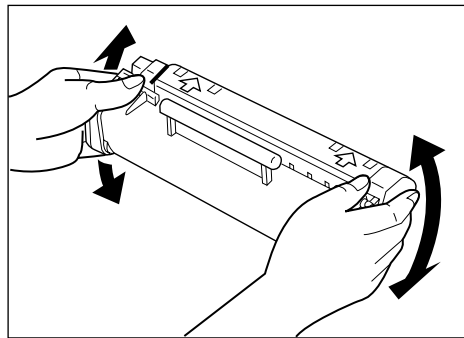

7 Place the cartridge on a flat, clean surface, and steady it with one hand. Remove the seal by gently pulling on the plastic tab with your other hand.

- Use a firm, even pull to remove the plastic seal. To avoid breaking the seal, do not jerk on it unevenly.

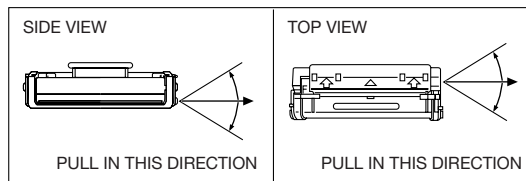
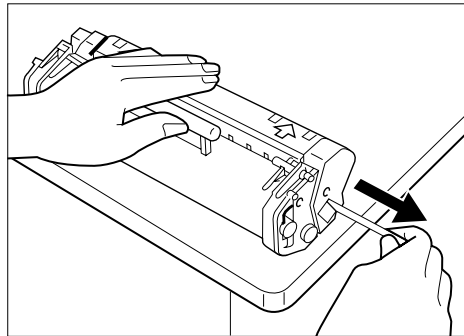

8 Insert the toner cartridge into the unit.

- Align the rails on the left and right sides of the cartridge with the guides inside the unit.
- Slide the unit into position.
- Always hold the cartridge by its handle when inserting it in the unit.

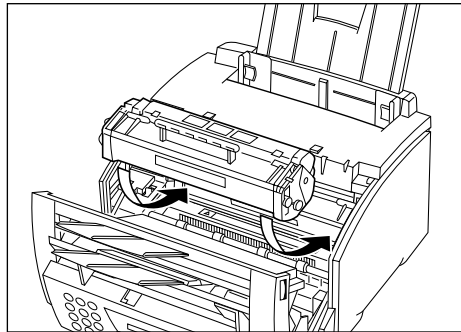

2

9 Gently press the cartridge into the unit as far as it will go.

- Press down and back on the cartridge's handle.

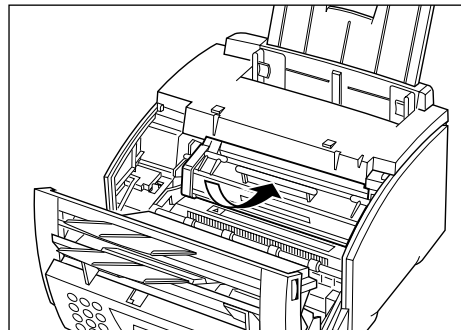

10 Close the front cover.

- Use both hands to lift the cover back into the closed position.

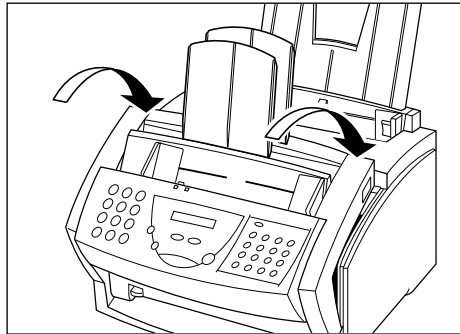

Loading Recording Paper

When the message LOAD PAPER appears in the LCD display, you need to add paper to the sheet feeder. Here are a few tips you should follow when you load paper into the sheet feeder.

- Use A4-size paper.
- Use standard 64–90 g/m² weight paper.
- The sheet feeder holds up to 100 sheets of standard weight paper* (maximum 10 mm stack height).
- Let the paper run out before you refill the sheet feeder. Avoid mixing new paper with paper remaining in the sheet feeder.
- Stack the paper so that the top and bottom edges and sides are straight and even before placing it in the sheet feeder.
- Do not print on both sides of the paper. Doing so may cause several sheets to feed into the unit at the same time.

2



- Do not use damp, curled, wrinkled, or torn paper as these can cause paper jams or poor print quality.
- Highly textured or extremely smooth or shiny paper does not print well.
- The laser printing process uses high temperatures to fuse toner to the paper. Use paper that will not melt, vaporise, discolour, or emit dangerous fumes at temperatures near 170°C. For example, do not use vellum paper in a laser printer. Make sure any letterhead or coloured paper you use can withstand high temperatures.
- Make sure the paper is free of dust, lint, and oil stains.
- To keep the paper from curling, do not open paper packs until you are ready to use the paper. Store unused paper from opened packs in a cool, dry location in the original packaging.
- Your FAX-L250 is factory-set to use A4-size paper. If you wish to use letter- or legal-size paper, you must change the setting from the FAX PRINTER menu. See Chapter 12, "The Menu System" for more details on changing the setting.



Do not load paper in the sheet feeder when the unit is printing.

* 75 g/m² paper

Setting Up Your FAX-L250

Follow these steps to load paper in the sheet feeder.



Let the paper run out before you refill the sheet feeder.

- 1** Before loading paper, stack it so that the leading edge and sides of the paper are even.

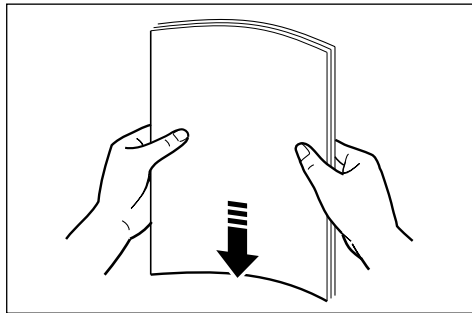

- 2** Open the paper guides to the approximate width of the stack of paper.

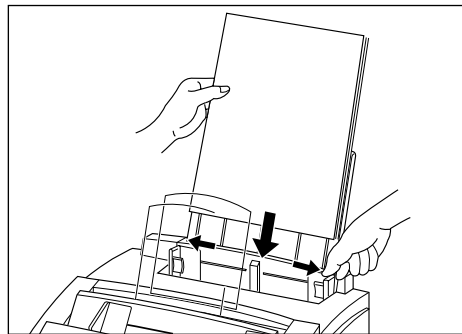

3 Insert the stack of paper— print side facing you and top edge first into the sheet feeder.

- Insert the stack until it stops, but do not force it in.

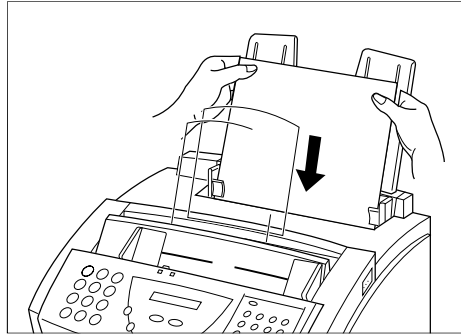

2

4 Adjust the paper guides to the width of the paper.

- Make sure there is no space between the paper guides and the stack of paper.

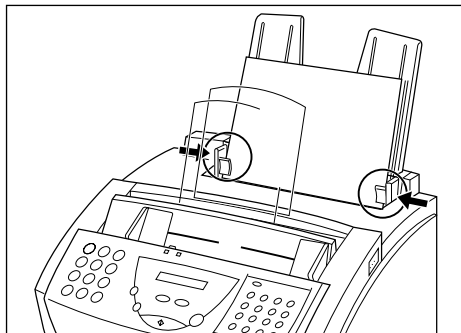

Your FAX-L250 is now ready to print.



Let the paper run out before you refill the sheet feeder. Avoid mixing new paper with paper remaining in the sheet feeder.



Testing the FAX-L250



After you have assembled your FAX-L250, installed the toner cartridge, loaded plain paper in the sheet feeder, you can make sure the FAX-L250 is printing properly by making several copies of a document. For instructions, see Chapter 8 "Making Copies".

Note the following:

- If the printed sheets are curled as they exit the FAX-L250, remove them from the output slot immediately to avoid paper jams.
- Make sure your text or graphics fall within the printable area.

The Paper Path

Understanding how paper feeds through the FAX-L250 will help you to determine how to load paper and handle paper jams.

The page travels first to the FX-3 toner cartridge. Here a laser beam "draws" the print image on the drum, then the drum applies toner to the page. The page then travels to the fixing assembly where the toner is fused to the page. The page then exits the unit from the front or top.

2

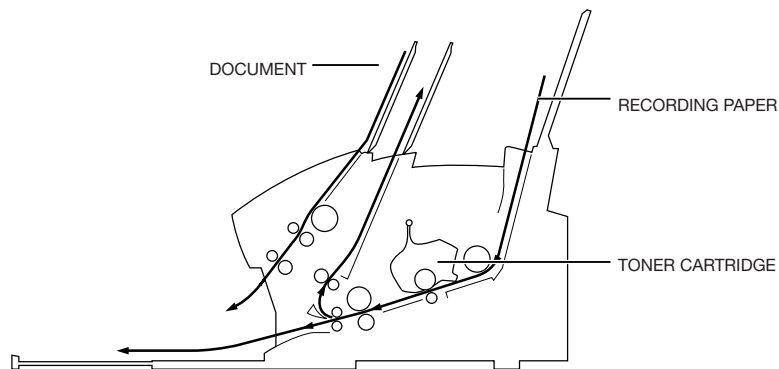

When you are printing, follow these guidelines:

- Always set the paper delivery selector before starting to print.
- Do not switch the paper delivery selector until the printout completely comes out of the delivery slot. Otherwise, a paper jam may occur.
- Make sure there is enough room for the paper to exit from the face-up delivery slot.
- Never pull the paper as it comes out of the unit.
- When using face-up delivery, receive each printout by letting it slide onto your open hand or onto the table.

Selecting Paper Delivery

Received faxes and copies can be delivered through the face-up or face-down delivery slots. Choose paper delivery according to the job the FAX-L250 is performing and the type of print media you are using.

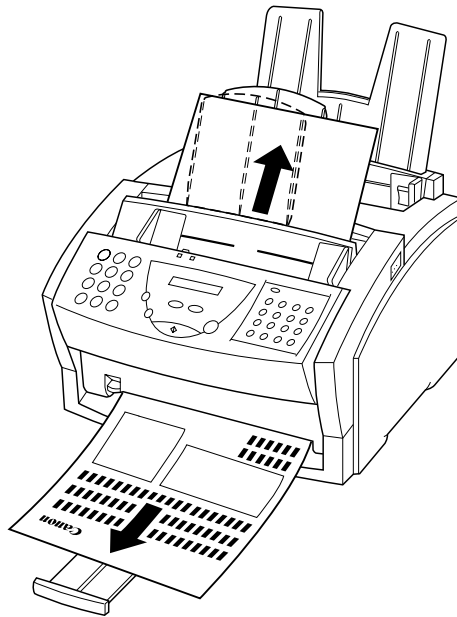

Face-Down Delivery

Face-down delivery is used for most jobs and when using plain paper only (64 to 90 g/m²). Printed pages are stacked in the order printed in the face-down delivery slot. This slot holds up to 50 sheets of plain paper (75 g/m²).

Move the paper delivery selector up to the  mark.

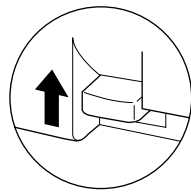

FACE-DOWN DELIVERY

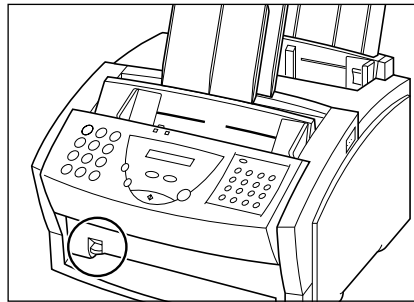

2

Face-Up Delivery

Printed pages come out through the face-up delivery slot in reverse order. Since there is no limit in the number of pages that can be delivered, this setting is convenient when receiving a large number of faxes, when making many copies, or when you plan to be away from your office or home for a long period of time.

Place the FAX-L250 on the edge of a table so that printed pages can come out without blocking the face-up delivery slot.

-
- 1** Move the paper delivery selector down to the  mark.

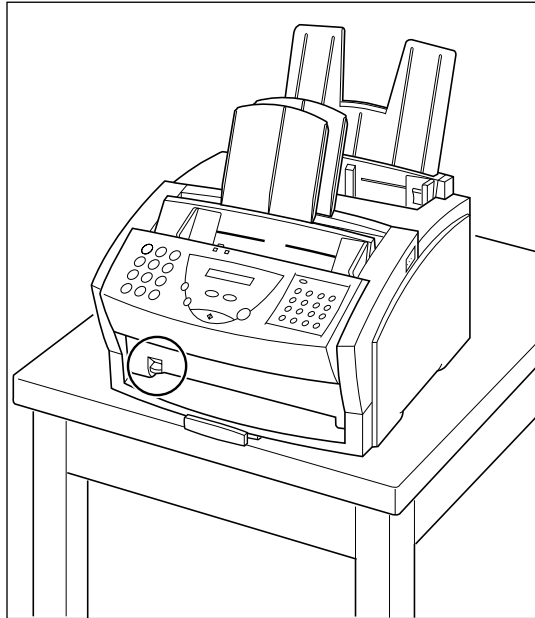
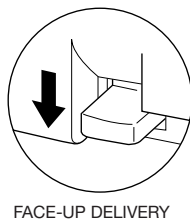

When using face-up delivery, make sure that the unit is placed as shown above so that the pages can drop away from the unit. If you do not place the unit as shown and prefer to use the extension tray, be sure to remove each page as it is delivered to avoid blocking the face-up delivery slot.

-
- 2** Make sure there is enough room for the paper to exit in front of the unit.

3

Registering Information in the FAX-L250

This chapter describes how to enter information in your FAX-L250.

Guidelines for Entering Information	3-2
Entering Numbers, Letters, and Symbols	3-3
Editing Information	3-5
Using the One-Touch Speed Dial/Special Function Buttons	3-6
Using the Menu System	3-6
Personalising Your FAX-L250	3-8
Identifying Your Documents	3-8
Entering the Date and Time	3-9
Registering Your Fax Number and Name	3-10
Setting the Telephone Line Type	3-12

Guidelines for Entering Information

The following section explains how to enter user information into the FAX-L250.



- If you pause while entering information and do not make an entry for more than 60 seconds, the FAX-L250 returns to standby mode and loses all information you had entered up to that point. You will then have to start over.
- If the FAX-L250 rings while you are entering information, press the ⏏ (STOP) button and lift the handset: The FAX-L250 will automatically save all the information you have entered up to the last time you pressed the ⏏ (START/COPY) button.
 - If you hear nothing or a slow beep, someone is trying to send a fax: press the ⏏ (START/COPY) button.
 - If you hear a voice, you are receiving a normal telephone call.
 - If your FAX-L250 is set to receive faxes automatically, you do not have to press the ⏏ (STOP) button. The FAX-L250 will automatically receive the fax. See Chapter 6 "Receiving Faxes".

Entering Numbers, Letters, and Symbols

Each numeric button has a number and a group of uppercase and lowercase letters assigned to it. Use the chart below to determine which number button to press for each character.

Button	Uppercase	Lowercase
1		
2	ABCÄÅÄÄÄÄÆÇ	abcäääääääæç
3	DEFÐËËËËË	defðëëëëë
4	GHIÏÏÏÏÏ	ghiïïïïï
5	JKL	jkl
6	MNOÑÒÓÔÔÔÔ	mnoñòóòòòò
7	PQRSP	pqrsp
8	TUVÜÚÚÚ	tuvüúúú
9	WXYZÝ	wxyzý
0		
*		
#	- . * # ! " , ; : ^ ` _ = / ' ? \$ @ % & + () [] { } < >	

3

Press the * button to change between number mode, uppercase letter mode, and lowercase letter mode.

When you are in number mode, "1" appears on the right of the LCD display.

— :1

When you are in uppercase letter mode, "A" appears on the right of the LCD display.

— :A

When you are in lowercase mode, "a" appears on the right of the LCD display.



— :a



To enter a symbol, press # repeatedly until the symbol you want appears. Press any other button or > to enter the symbol and move the cursor.

Registering Information in the FAX-L250

Entering a single letter

For example, you would enter a lowercase letter "b" like this:



1 Press * until an "a" appears on the right of the LCD display.  



2 Press 2 twice to display "b" on the left of the LCD display.   



Entering two letters from the same group

To enter two letters from the same group, you have to use the right arrow button (>). For example, you would enter "AA" like this:

1 Press * until an "A" appears on the right of the LCD display.  

2 Press 2 once to display the first "A" on the left of the LCD display.  

3 Press > to enter the "A" and move the cursor to the right.  

4 Press 2 until the second "A" is displayed.  

■ **Editing Information**

If you make a mistake while entering a name, you can correct it by using the < and > buttons.

1 Use the > button to scroll to the incorrect character.

2 Press the < button once to erase the character above the cursor. (The cursor moves one space to the left.)

3 Press the > button to move back to the empty space and type in the correct character.

3

Using the One-Touch Speed Dial/Special Function Buttons

The one-touch speed dial/special function buttons allow you to use speed dialling and special functions such as delayed fax transmission, printing reports, and sending with a password/subaddress. The **FUNCTION** button switches the buttons' functions between one-touch speed dialling and special functions.

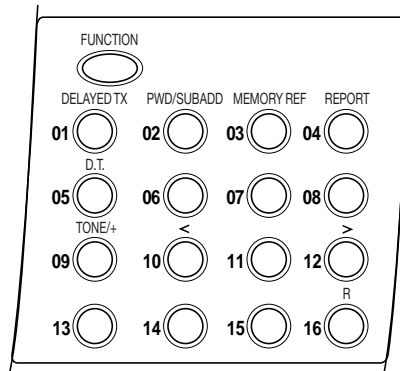

Using the Menu System

The FAX-L250 includes a menu system under the **FUNCTION** button that allows you to select operation settings, and to enter user information. The system includes these items:

■ TEL REGISTRATION

Lets you register numbers for one-touch speed dialling, coded speed dialling, and group dialling.

■ USER SETTINGS

Lets you enter the information that prints on the faxes you send, to set scanning contrast, and to enter other basic data. Enter these settings when you plug your unit in for the first time; you will rarely need to change them thereafter.

■ **REPORT SETTINGS**

Lets you set the unit to print a report every time you send or receive a fax, and also contains options for printing summary reports.

■ **TX SETTINGS**

Contains items that let you customise how your unit sends documents.

■ **RX SETTINGS**

Allows you to customise how your unit receives documents.

■ **FAX PRINTER**

Lets you customise how your unit prints documents.

■ **SYSTEM SETTINGS**

Allows you to set the date format, transmission and receive speed, etc.

For details, see Chapter 12, "The Menu System".

You'll use the arrow buttons to display and select items from the menu system, as follows:

1 Press **FUNCTION**.



2 Use **<** or **>** to change the menu display.

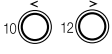

- Press the **>** button to display the next item in the menu. (The list will wrap from the last item in the list back to the first.)
- Press the **<** button to display the previous item in the menu. (The list will wrap from the first item in the list back to the last.)

3 Press **START/COPY** to select an item from the menu, or press **STOP** to cancel the menu selection and return to standby mode.



Personalising Your FAX-L250

Identifying Your Documents

When sending documents, you can have your fax number, your name, and the current date and time printed out by the receiving fax. This information is called your TTI (Transmit Terminal Identification) and appears at the top of the faxed document in small type.

By identifying the documents you send, the receiving party can recognise your fax messages at a glance. Here is a sample document with the identifying information:

	07/09 '98 MON 10:12 FAX 321 456 7777	CANON U.K.	... CANON USA FAX	001
THE DATE AND TIME YOU SENT THE DOCUMENT	THE SIEREXE COMPANY LIMITED SAPORS LANE - BOOLE - DORSI F - BH 25 8 ER TELEPHONE DOOLE 195 13 5101 TELEX 121456			
YOUR FAX/ TELEPHONE NUMBER				
YOUR NAME OR COMPANY NAME	Our Ref. 350/BJC/EAC			
THE NAME OF THE PARTY WHO IS RECEIVING THE "FAX"				
THE PAGE NUMBER				



* If you send a fax using speed dialling, the top line also includes the name registered under the speed dialling button or code you entered.



You can enter this information into the FAX-L250 by following the instructions on the pages below.



Entering the Date and Time

Follow these steps to enter the date and time:



- 1** Press **FUNCTION**.



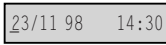

- 2** Use **<** or **>** to select **USER SETTINGS**.



- 3** Press **START/COPY**.



- 4** Press **START/COPY** again, then use the numeric buttons to type in the correct date and time.

 - Use the DD/MM 'YY format for the date and use the 24-hour clock for the time, so 2:30 p.m. would be 14:30, for example.)

- 5** Press **START/COPY** to save the date and time.















- 6** Press **STOP** to return to standby mode.



3

Registering Your Fax Number and Name

Use the following procedure to register your fax/telephone number and name.

- 1** Press **FUNCTION**.
 
- 2** Use or < or > to select to select **USER SETTINGS**.
  
- 3** Press **START/COPY**.
 
- 4** Use or < or > to select **UNIT TELEPHONE #**.
  
- 5** Press **START/COPY**, then enter your fax/telephone number using the numeric buttons.
  
 - You can enter up to 20 digits for your fax number.
 - You can enter spaces with the > button to make the number easier to read.

6 Press **START/COPY** to save the fax/telephone number.  UNIT NAME

7 Press **START/COPY** again, then use the numeric buttons to type in your name or business name.   CANON :A

- For more details on entering letters, see page 3-3
- You can enter up to 24 characters for your name or business name.

8 Press **START/COPY** to save the name.  TX TERMINAL ID



















3

9 Press **STOP** to return to standby mode.  14:30 FaxOnly

Setting the Telephone Line Type

Use this procedure if you need to change the factory-set telephone line setting.*

If you are unsure which setting to use, contact your local telephone company.

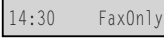
- 1** Press **FUNCTION**.
 
- 2** Use **<** or **>** to select **USER SETTINGS**.
  
- 3** Press **START/COPY**.
 
- 4** Use **<** or **>** to select **TEL LINE TYPE**.
  
- 5** Press **START/COPY**, then use **<** or **>** to select the correct telephone line type.
   

- 6** Press **START/COPY** to save the telephone line type.
 
- 7** Press **STOP** to return to standby mode.
 

* The factory default setting is **ROTARY PULSE** for all countries except the UK and Singapore. The factory default setting for the UK and Singapore is **TOUCH TONE**.

4

Speed Dialling

This chapter describes how to register and use the speed dialling features of the FAX-L250.

Speed Dialling Methods	4-2
One-Touch Speed Dialling	4-3
Storing Numbers for One-Touch Speed Dialling	4-3
Changing a Number/Name Stored under a	
One-Touch Speed Dialling Button	4-6
Using One-Touch Speed Dialling	4-9
Coded Speed Dialling	4-11
Storing Numbers for Coded Speed Dialling	4-11
Changing a Number/Name Stored under a Coded	
Speed Dialling Code	4-14
Using Coded Speed Dialling	4-17
Group Dialling	4-19
Creating Groups for Group Dialling	4-19
Using Group Dialling	4-22



Speed Dialling Methods



In addition to regular dialling, the FAX-L250 provides several ways to dial fax/telephone numbers automatically.

■ **One-touch speed dialling**

Dial a fax/telephone number by pressing the one-touch speed dialling button that the number is assigned to.

■ **Coded speed dialling**

Dial a fax/telephone number by pressing the **CODED DIAL** button followed by a two-digit code assigned to that number.













■ **Group dialling**

Send a document to a pre-defined group of fax numbers. (The numbers must already be stored as one-touch speed dialling numbers or coded speed dialling numbers.)

One-Touch Speed Dialling

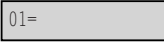
Storing Numbers for One-Touch Speed Dialling

Your FAX-L250 can store up to 16 of your most frequently dialled numbers under one-touch speed dialling buttons. Follow this procedure to store one-touch speed dialling numbers and names.

- 1** Press **FUNCTION**.
 
- 2** Use **< or >** to select **TEL REGISTRATION**.
  
- 3** Press **START/COPY** twice.
  

- 4** Use **< or >** to select a one-touch speed dialling button between 01 and 16.*
  

- If a number is already stored under the button you select, that number appears.
- If the button you select is registered for group dialling, **GROUP DIAL** appears.

* Users in the UK only: If you have set the M-KEY SETTING in the USER SETTINGS to ON, "M-KEY" will be displayed if you select the one-touch speed dialling button 16. You cannot use this button for one-touch speed dialling.

4

Speed Dialling

5 Press **START/COPY**.



TELEPHONE NUMBER

6 Press **START/COPY** again, then use the numeric buttons to enter the number you want to store.



Ex:

TEL= 20 545 8545

- The number can be up to 120 digits long.
- Press the > button to enter spaces between numbers (spaces are optional and are ignored during dialling).
- If you want to clear a mistaken entry, press the < button.
- To enter a pause in the number, press the **REDIAL/PAUSE** button one or more times.*

7 Press **START/COPY**.



NAME

8 Press **START/COPY** again, then use the numeric buttons to store the name that goes with the number.



Ex:

Canon EUROPA :A

- For details on entering letters, see page 3-3.
- You can store up to 16 characters for the name.

* Users in the UK can only enter one pause between digits in telephone/fax numbers.

9 Press **START/COPY**



05=

10 To continue registering numbers and names, repeat steps 4 to 9.













14:30 FaxOnly

-or-

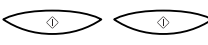
If you have finished registering numbers and names, press **STOP** to return to standby mode.

Changing a Number/Name Stored under a One-Touch Speed Dialling Button

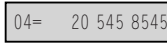
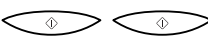
Follow these steps if you want to change a number and/or name registered under a one-touch speed dialling button, or if you want to delete all information stored under a button.

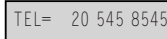
- 1** Press **FUNCTION**.
 
- 2** Press **< or >** to select **TEL REGISTRATION FUNCTION**.
 
- 3** Press **START/COPY** twice.
 

- 4** Use **< or >** to select the one-touch speed dialling button you want to change (between 01 and 16*).
 
 - If the button you select is registered for group dialling, **GROUP DIAL** appears.
- 5** Press **START/COPY** twice.
 

* Users in the UK only: If you have set the **M-KEY SETTING** in the **USER SETTINGS** to **ON**, "M-KEY" will be displayed if you select the one-touch speed dialling button 16. You cannot use this button for one-touch speed dialling.

To delete a number:

6 Press < until the whole number is deleted, then press **START/COPY**.



- When you delete a number, the name registered for that number is also deleted.

7 Press **STOP** to return to standby mode.



To change the number and/or name:

6 To change the number, use the numeric buttons to enter the new number over the previous number.

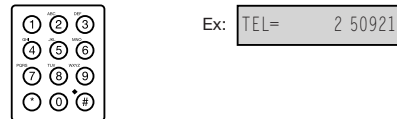

- The telephone/fax number can be up to 120 digits long.
- If you only want to change the name, ignore this step and go to step 7.

7 Press **START/COPY** twice to display the registered name.

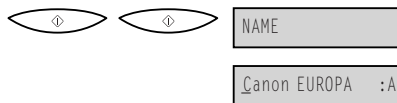

Speed Dialling

8 To change the name, use the numeric buttons to enter the new name over the previous name.

- For details on entering letters, see page 3-3.
- You can enter up to 16 characters for the name.
- If you want to keep the same name, do not enter a new name and go to step 9.



Ex: Canon ITALIA :A

9 Press **START/COPY** twice to display the registered name.



05= 1 432 2060

10 To change additional numbers and/or names, repeat steps 4 to 9.



14:30 FaxOnly

-or-

If you have finished changing numbers and/or names, press **STOP** to return to standby mode.

Using One-Touch Speed Dialling

Once you have registered your numbers under one-touch speed dialling buttons, you can use them to send documents as follows:



Be sure to adjust the document feed lever before loading your document. See page 5-6 for more details.

1 Prepare the document and load it, face down, into the Automatic Document Feeder (ADF).

- If necessary, you can adjust the resolution and contrast. See page 5-13 for more details.

2 Press the one-touch speed dialling button assigned to the number to which you wish to fax.



Ex:

TEL=CANON U.K.

- The name registered under that one-touch speed dialling button is displayed. If no name is registered, the number registered under that button will be displayed.
- If you mistakenly press the wrong one-touch speed dialling button, press the  (STOP) button then press the correct button.
- If no fax number is assigned to the one-touch dialling button you press, the LCD displays **NO TEL #**. If this happens, make sure you pressed the correct button and that the number you want to dial is registered under that button.

4

3 Press START/COPY.



- If you do not press the  (START/COPY) button within five seconds of pressing the one-touch speed dialling button, the FAX-L250 will begin sending automatically.
- If an error occurs during sending, the FAX-L250 will print an error report. If this happens, try sending the fax again. See "Faxing Problems" on page 10-20 for details about errors.

Speed Dialling











You can also use one-touch speed dialling to send a document to more than one location at a time. For details, see "Sequential Broadcasting" on page 5-29.

Coded Speed Dialling

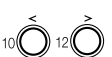
Storing Numbers for Coded Speed Dialling

You can store up to 100 numbers for coded speed dialling. Follow this procedure to store coded speed dialling numbers and names.

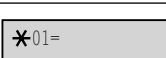
- 1** Press **FUNCTION**.
 
- 2** Press **< or >** to select **TEL REGISTRATION**.
 
- 3** Press **START/COPY**, then use **< or >** to select **CODED SPEED DIAL**.
  
- 4** Press **START/COPY**.
 
- 5** Use **< or >** to select a two digit code (00-99) in the display.
 

- If a number is already registered under the code you select, that number is displayed.
- If the code you select is registered for group dialling, **GROUP DIAL** appears.

4

Speed Dialling

6 Press **START/COPY** twice.

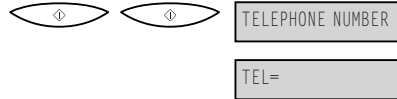

7 Use the numeric buttons to enter the number you want to store.

- The number can be up to 120 digits long.
- Press the > button to enter spaces between numbers (spaces are optional and are ignored during dialling).
- If you want to clear a mistaken entry, press the < button.
- To enter a pause in the number, press the **REDIAL/PAUSE** button one or more times.*



Ex: TEL= 1 538 4500

8 Press **START/COPY**.



9 Press **START/COPY** again, then use the numeric buttons to store the name that goes with the number.



- For details on entering letters, see page 3-3.
- You can store up to 16 characters for the name.

* Users in the UK can only enter one pause between digits in telephone/fax numbers.

10 Press **START/COPY**.  

















11 To continue registering numbers and names, repeat steps 5 to 10.  

-or-

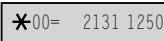
If you have finished registering numbers and names, press **STOP** to return to the standby mode.

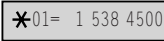
Changing a Number/Name Stored under a Coded Speed Dialling Code

Follow these steps if you want to change the number and/or name registered under a coded speed dialling code, or if you want to delete all information stored under a code.

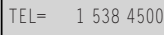
- 1** Press **FUNCTION**.
 
- 2** Use **<** or **>** to select **TEL REGISTRATION**.
  
- 3** Press **START/COPY**, then use **<** or **>** to select **CODED SPEED DIAL**.
   
- 4** Press **START/COPY**.
 
- 5** Use **<** or **>** to select the coded speed dialling code you want to change (between 00 and 99).
  
 - If the button you select is registered for group dialling, **GROUP DIAL** is displayed.
- 6** Press **START/COPY** twice.
  

To delete a number:

7 Press < until the whole number is deleted, then press **START/COPY**.



- When you delete a number, the name registered for that number is also deleted.

8 Press **STOP** to return to standby mode.



To change the number and/or name:

7 To change the number, use the numeric buttons to enter the new number over the previous number.

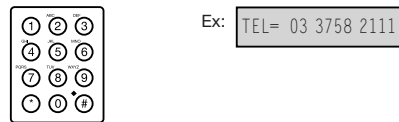

- The telephone/fax number can be up to 120 digits long.
- If you only want to change the name, ignore this step and go to step 8.

8 Press **START/COPY** twice to display the registered name.

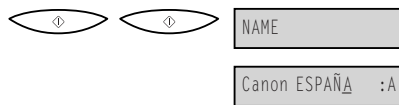

4

Speed Dialling

9 To change the name, use the numeric buttons to enter the new name over the previous name.

- For details on entering letters, see page 3-3.
- You can enter up to 16 characters for the name.
- If you want to keep the same name, do not enter a new name and go to step 10.

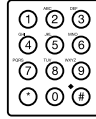

Ex:

10 Press **START/COPY**.



11 To change additional numbers and/or names, repeat steps 5 to 10.



-or-

If you have finished changing numbers and/or names, press **STOP** to return to standby mode.

Using Coded Speed Dialling

Once you have registered your numbers under coded speed dialling codes, you can send documents as follows:



Be sure to adjust the document feed lever before loading your document. See page 5-6 for more details.

1 Prepare the document and load it, face down, into the Automatic Document Feeder (ADF).

- If necessary, you can adjust the resolution and contrast. See page 5-13 for more details.

2 Press CODED DIAL.

CODED DIAL



*

3 Use the numeric buttons to enter the two-digit code assigned to the fax number.



*03

TEL=CANON U.S.A

4

- The name registered under that coded speed dialling code is displayed. If no name is registered, the number registered under that code will be displayed.
- If you mistakenly enter the wrong code, press the (STOP) button. Then press the (CODED DIAL) button and enter the correct code.
- If no fax number is assigned to the coded speed dialling code you press, the LCD displays **NO TEL #**. If this happens, make sure you entered the correct code and that the number you want to dial is registered under that code.

Speed Dialling

4 Press **START/COPY**.



- If you do not press the  (**START/COPY**) button within five seconds of entering the coded speed dialling code, the FAX-L250 will begin sending automatically.
- If an error occurs during sending, the FAX-L250 will print an error report. If this happens, try sending the fax again. See "Faxing Problems" on page 10-20 for details about errors.



You can also use coded speed dialling to send a document to more than one location at a time. For details, see "Sequential Broadcasting" on page 5-29.







Group Dialling

If you frequently send faxes to the same group of numbers, you can create a "group". Groups are stored under one-touch speed dialling buttons or coded speed dialling codes and can contain as many as 115 numbers.

Creating Groups for Group Dialling



The numbers you use in a group must already be stored under one-touch speed dialling buttons or coded speed dialling codes. Each group is stored under a one-touch speed dialling button or a coded speed dialling code.

Create groups for group dialling as follows:

- 1** Press **FUNCTION**.
 
- 2** Use **< or >** to select **TEL REGISTRATION**.
 
- 3** Press **START/COPY**, then use **< or >** to select **GROUP DIAL**.
 
- 4** Press **START/COPY**.

4

To store a group under a one-touch speed dialling button:

- 5** Use **< or >** to select an unused one-touch speed dialling button (01 to 16*).
 Ex: 
 - If a group or number is already registered under the button you select, **GROUP DIAL** or **1-TOUCH SPD DIAL** is displayed.

* Users in the UK only: If you have set the **M-KEY SETTING** in the **USER SETTINGS** to **ON**, "M-KEY" will be displayed if you select the one-touch speed dialling button 16. You cannot use this button for group dialling.

Speed Dialling

To store a group under a coded speed dialling code:

- 5** Press **CODED DIAL**, then use the numeric buttons to enter an unused two-digit code (00 to 99).

CODED DIAL

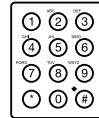

Ex:

*21=

- If a group or number is already registered under the code you select, **GROUP DIAL** or **CODED SPEED** is displayed.



- Each one-touch speed dialling button or coded speed dialling code can store either a name and number for speed dialling, or a group. Be careful not to override speed dialling numbers and names when creating and registering groups.
- If you wish to register a group under a one-touch speed dialling button or coded speed dialling code already registered for speed dialling, or if you want to re-enter a group, you must delete the previous information first. See pages 4-6 and 4-14 for more details.

- 6** Press **START/COPY** twice.

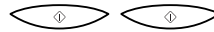

TELEPHONE NUMBER

TEL=

- 7** Enter the speed dialling numbers you want to store in the group.



01=CANON EUROPE

- To enter in the group a number stored under a one-touch speed dialling button, press **FUNCTION**, then press the desired one-touch speed dialling button (s).

- To enter a number stored under a coded speed dialling code, press **CODED DIAL**, then enter the two-digit code for the number using the numeric buttons.
- For multiple entries, press **CODED DIAL** between each entry.







- You cannot register numbers in the groups that have not been registered for speed dialling.
- You can review the numbers registered under the group by pressing the > button.
 - If you want to delete one of these numbers from the group, press < (**ERASING END** is displayed) and then the **START/COPY** button.
 - If you want to delete all the numbers in the group, press < repeatedly until all numbers are deleted, and then press the **START/COPY** button. Deleting all numbers will cancel the group.
 - If you want to add a number to the group, press the one-touch speed dialling button or coded speed dialling code the number is registered under, and then press the **START/COPY** button. The number will be added to the group.
- You can cancel registering numbers and return to standby mode by pressing the ⏏ (**STOP**) button anytime before pressing the ⏏ (**START/COPY**) button in step 8.

4

8 Press < until the whole number is deleted, then press **START/COPY** twice, then use the numeric buttons to enter a name for the group.





NAME

Canon GROUP 1 :1

- See page 3-3 for details on entering letters.
- You can enter up to 16 characters for the name.

9 Press **START/COPY**.



10 To enter additional groups, repeat steps 5 to 9.



14:30 FaxOnly

-or-

If you have finished registering groups press **STOP** to return to standby mode.

Using Group Dialling

To send a document to a group of numbers, follow these instructions.



Be sure to adjust the document feed lever before loading your document. See page 5-6 for more details.

1 Prepare the document and load it, face down, into the Automatic Document Feeder (ADF).

- If necessary, you can adjust the resolution and contrast. See page 5-13 for more details.

2 Enter the group (s) stored under a one-touch speed dialling button (s) and/or coded speed dialling code (s).

- The name registered under that one-touch speed dialling button or coded speed dialling code is displayed. If no name is registered, **GROUP DIAL** will be displayed.
- If you make a mistake when selecting a group, press the  (**STOP**) button and start again.
- If you press a one-touch speed dialling button or coded speed dialling code that has no group (or fax number) registered under it, the LCD displays **NO TEL #**. Make sure you pressed the correct one-touch speed dialling button or entered the correct coded speed dialling code, and that the group you want has been registered correctly under that button or code.
- After entering the first one-touch speed dialling button or coded speed dialling code, you have five seconds to enter another speed dialling button or code before the FAX-L250 begins sending automatically. If you have entered more than one speed dialling button or code, the FAX-L250 waits for 10 seconds before it begins sending.

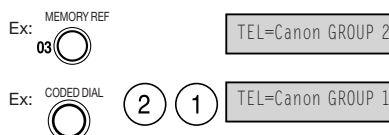

3 When you finish entering groups, press
START/COPY.



- The FAX-L250 then scans the document into memory, and begins dialling the numbers in the groups.

4

This page is intentionally blank.

5

Sending Faxes

This chapter describes how to use your FAX-L250 to send faxes.

Preparing to Send a Fax	5-3
Document Requirements	5-3
Scanning Area	5-5
Selecting Automatic/Manual Document Feed	5-6
Loading Documents for Automatic Feed	5-7
Loading Documents for Manual Feed	5-11
Setting the Resolution and Contrast	5-13
Setting the Scanning Resolution	5-13
Setting the Scanning Contrast	5-14
Sending Methods	5-15
Manual Sending via the Handset	5-15
Memory Sending	5-15
Dialling Methods	5-15
Sending Documents	5-16
Manual Sending via the Handset	5-16
Memory Sending	5-18
Adding Pages to the Document in the Automatic Document Feeder (ADF)	5-20
Cancelling Sending	5-21
Removing the Document from the Automatic Document Feeder (ADF)	5-22
Redialling	5-24
Manual Redialling	5-24
Automatic Redialling with Memory Sending	5-24
Cancelling Automatic Redialling	5-25
Setting Up Automatic Redialling	5-26

Sequential Broadcasting	5-29
Sending a Document to More than One Destination ...	5-29
Sending a Document Using Group Dialling	5-31
Delayed Sending	5-32
Sending Other Documents While the FAX-L250 is Set for Delayed Sending	5-34
Documents Stored in Memory	5-35
Printing a List of Documents Stored in Memory	5-35
Deleting a Document Stored in Memory	5-37
Resending a Document that Encountered an Error	5-38
Sending with the Password/Subaddress Feature	5-40
If a Power Cut Occurs	5-43



Preparing to Send a Fax

Before you can send a fax, you need to load the document into the FAX-L250. For instructions and information about the types of documents you can scan with the FAX-L250, see below.

Document Requirements

The documents you load into the FAX-L250 must meet these requirements:

When the document feed lever is set to Automatic Document Feed:

- Size:**
- Maximum: 216 × 355.9 mm
 - Minimum: 105 × 148 mm
- Quantity:**
- Up to 20 A4-size, 20 letter-size, or 10 legal-size pages (1 page for sizes other than these)
- Thickness:**
- 0.07–0.13 mm (For pages thicker than this, load one page at a time)
 - All sheets should be of the same thickness.
- Weight:**
- 50–90 g/m²
 - All sheets should be of the same weight.

When the document feed lever is set to Manual Document Feed:

- Size:**
- Maximum: 216 mm × approx. 1 m
 - Minimum: 88.9 × 44.5 mm
- Quantity:**
- 1 page
- Thickness:**
- 0.06–0.3 mm
- Weight:**
- 40–340 g/m²



Problem documents

- To prevent paper jams in the Automatic Document Feeder (ADF), do not use any of the following paper in the FAX-L250:



WRINKLED OR CREASED
PAPER

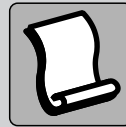

CURLED OR ROLLED
PAPER



TORN PAPER

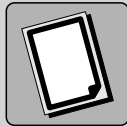

CARBON PAPER OR
CARBON-BACKED PAPER

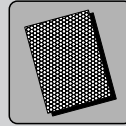

COATED PAPER

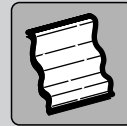

ONION SKIN OR THIN
PAPER

- Remove all staples, paper clips, or any other fasteners before loading the document into the Automatic Document Feeder (ADF).
- Make sure any glue, ink, or correction fluid on the paper is completely dry before loading the document into the Automatic Document Feeder (ADF).
- If you have a document that will not feed into the FAX-L250 properly, make a photocopy of the document, then load the copy instead.

■ **Scanning Area**

The FAX-L250 does not scan the areas within the maximum margins of 3.0 mm on either side of the sheet and 4.0 mm on the top and bottom. Make sure your document's text and graphics do not extend into these margins.

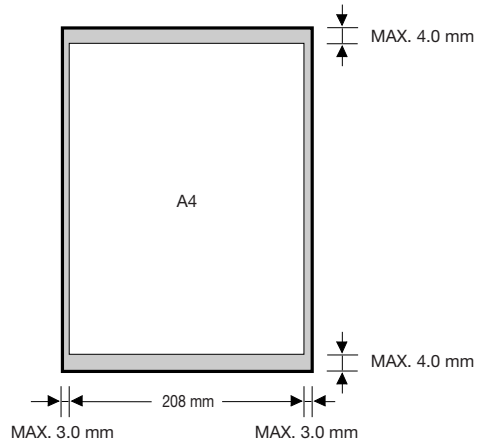

Selecting Automatic/Manual Document Feed

With the FAX-L250, you can select whether you want to scan documents automatically or manually.

Automatic document feeding is used when scanning multipage documents on normal paper. Use manual document feeding when scanning single-page documents such as photos, business cards, or documents on other special types of paper. Manual document feed will allow you to scan your document with minimum damage to the surface of the document.



When using manual feed, use a carrier sheet to avoid scratching the surface of important documents (photographs, for example).

Use the document feed lever located at the top of the operation panel, to select automatic document feed or manual document feed.

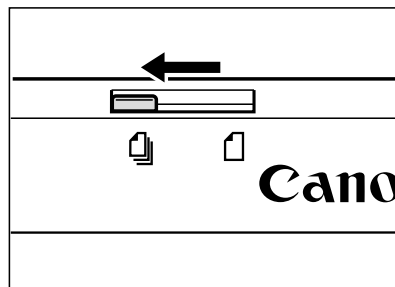

Automatic document feed

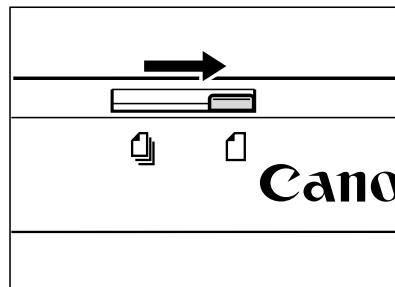

Manual document feed

■ Loading Documents for Automatic Feed

- 1** Make sure the document feed lever is set to automatic document feed.

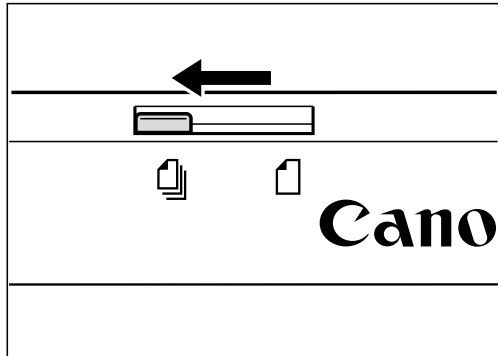

- 2** If the document has multiple pages, tap it on a flat surface to even the edges.

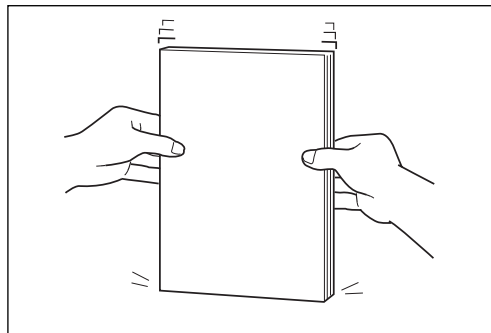

5

Sending Faxes

- 3** Adjust the document guides to the width of the document.

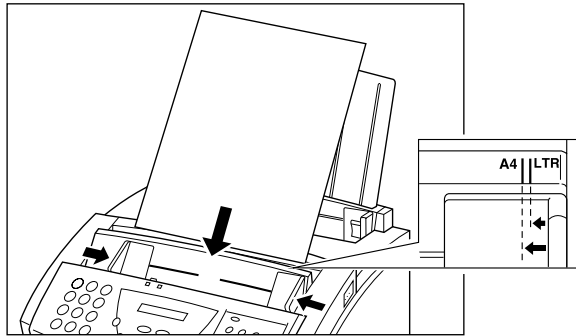

- 4** Gently insert the document face down (top of the document towards you) into the Automatic Document Feeder (ADF) until it stops.

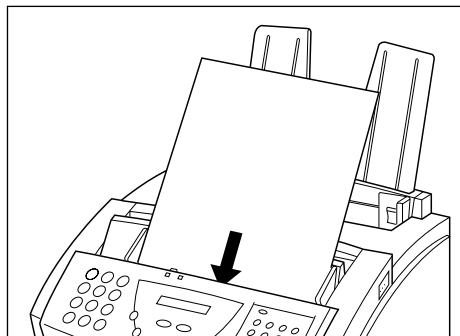

The document is now ready for scanning. The FAX-L250 automatically feeds the pages one by one from the bottom of the stack.

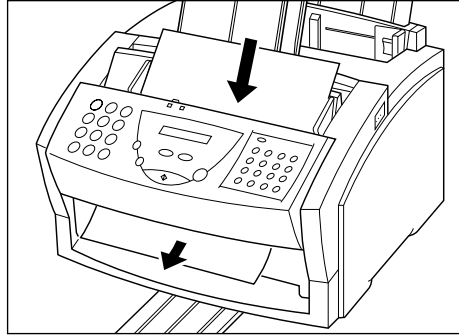

Wait until your document has been scanned completely before inserting a new document.

Trouble With Multipage Documents

If you have trouble feeding a multipage document, do the following:

- 1** Remove the stack and tap it on a flat surface to even the edges.

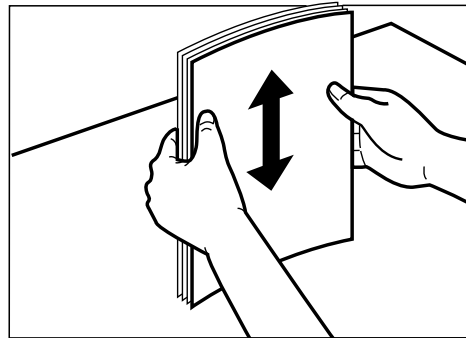

- 2** Gently insert the stack into the Automatic Document Feeder (ADF) until it stops.

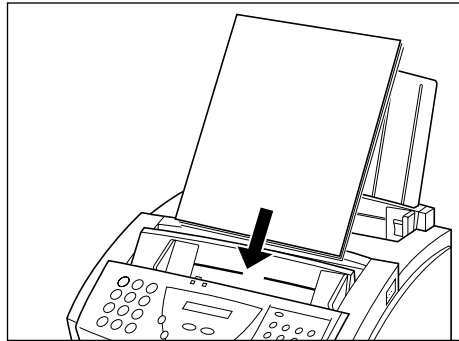

- If you have further trouble with page jams while feeding, see "Jams in the Automatic Document Feeder (ADF)" on page 10-5.
- You cannot feed a multipage document of thick media, such as postcards or business cards. Use manual feed instead to feed one page at a time.
- Wait until your document has been scanned completely before inserting a new document.

■ Loading Documents for Manual Feed

- 1** Make sure the document feed lever is set to manual document feed.



When using manual feed, use a carrier sheet to avoid scratching the surface of important documents (photographs, for example).

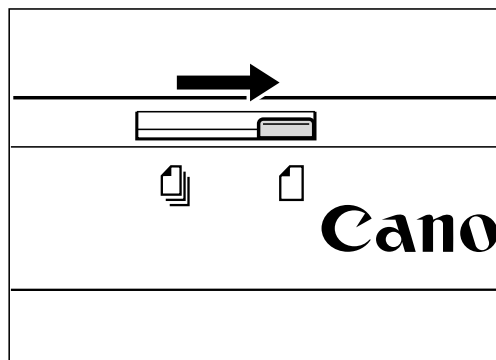

- 2** Adjust the document guides to the width of the document.

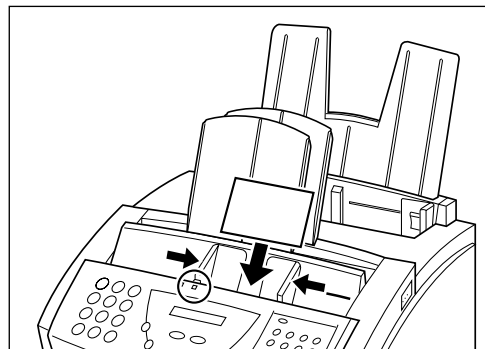

5

Sending Faxes

- 3** Gently insert the document face-down (top of the document towards you) into the Automatic Document Feeder (ADF) until it stops.

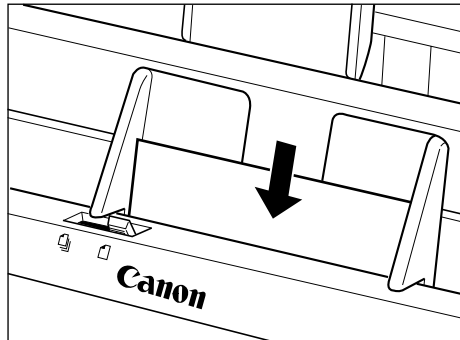

The document is now ready for scanning.



- Wait until your document has been scanned completely before inserting a new document.
- The length of the document is slightly reduced when copying or sending documents using manual feed.

Setting the Resolution and Contrast

■ Setting the Scanning Resolution

Canon's Ultra High Quality (UHQ™) imaging technology enables you to send faxes with a print quality that is very close to that of the original document. The FAX-L250 also lets you adjust the resolution it uses in sending faxes to best suit your particular document.

The FAX-L250 has three resolution settings:

- **STANDARD** resolution (203 × 98 dpi) is adequate for most text documents.
- **FINE** resolution (203 × 196 dpi) is suitable for documents with fine print (smaller than the print in this sentence).
- **PHOTO** resolution (203 × 196 dpi, with halftones) is for documents that contain photographs. With this setting, areas of the document that contain photos are automatically scanned with 64 levels of grey, rather than just two (black and white). This gives a much better reproduction of the photos, though transmission time is longer.

Set the resolution as follows:

- 1** Press **RESOLUTION**.

- The LCD display shows the current resolution setting.



The LCD display shows the word "RESOLUTION" above a circle containing the word "STANDARD".

- 2** Press **RESOLUTION** until the resolution you want is displayed.

- The LCD display shows the current resolution setting.

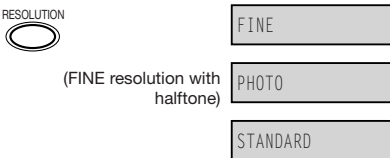

The LCD display shows the word "RESOLUTION" above a circle containing the words "FINE", "PHOTO", and "STANDARD". Below the circle, the text "(FINE resolution with halftone)" is displayed.

- 3** Continue with the operation you wish to complete.



















- If you do not proceed with any other operation, the LCD display returns to standby mode after about 5 seconds.



The LCD display shows "14:30" and "FaxOnly".

■ Setting the Scanning Contrast

Contrast is the difference in brightness between the lightest and darkest parts of a printed document. You can adjust the contrast the FAX-L250 uses when scanning documents to be sent. **STANDARD** is the default setting and is adequate for most documents. To darken a light original, set to **DARKER**; to lighten dark originals, use **LIGHTER**.

- 1** Press **FUNCTION**.
 
- 2** Use **< or >** to select **USER SETTINGS**.
  
- 3** Press **START/COPY**, then use **< or >** to select **SCAN CONTRAST**.
   
- 4** Press **START/COPY**.
 
 - The currently set scanning contrast is displayed.
- 5** Press **< or >** to select the scanning contrast you wish to set.
 
 - You can select **STANDARD**, **LIGHTER**, or **DARKER**.
 - You can cancel and return to standby mode by pressing the  (**STOP**) button any time before pressing the  (**START/-COPY**) button in step 6.
- 6** Press **START/COPY** to save your selection, then press **STOP** to return to standby mode.
  

Sending Methods

■ Manual Sending via the Handset

Use manual sending via the handset if you want to speak with the other party before sending a fax to them. With manual sending via the handset, you dial, converse normally and when they are ready to receive your fax, press the **START/COPY** button to begin sending. See page 5-16 for more details on manual sending via the handset.

■ Memory Sending

Memory sending allows you to send a document easily and quickly. This method of sending scans the document into memory, and as the first page of a multipage document is being scanned, the FAX-L250 already begins calling the other party and transmitting the information even as the remaining pages are being scanned.

To use memory sending, you load the document, dial the fax number and press the **START/COPY** button. See page 5-18 for more details on memory sending.

Since the FAX-L250 is multitasking, you can even scan a document into the memory while sending a document, receiving a document, or printing a report.

Dialling Methods

There are several ways of dialling the number of the party you want to send to:

■ Regular dialling

Use the numeric buttons to dial the recipient's fax number.

■ One-touch speed dialling

Press the one-touch speed dialling button (1 to 16) under which you have registered the number you want to send to. See Chapter 4 "Speed Dialling" for details on registering and using one-touch speed dialling.

■ Coded speed dialling

Press **CODED DIAL** and enter the two-digit code (00 to 99) under which you have registered the number you want to send to. See Chapter 4 "Speed Dialling" for details on registering and using coded speed dialling.

Sending Documents

This section describes the different ways to send faxes with the FAX-L250.

Manual Sending via the Handset

If you have the optional handset or a telephone connected to your FAX-L250, you can send faxes manually. This allows you to talk to the other party before sending the fax, which can be useful if the other party uses a single line for both voice and fax transmissions.



Be sure to adjust the document feed lever before loading your document. See page 5-6 for details.

1 Prepare the document and load it, face down, into the Automatic Document Feeder (ADF).

- Once the document is loaded, the LCD display shows the following:
- If necessary, you can adjust the resolution and contrast. See page 5-13 for details.

Currently used memory: MEMORY USED 0%

Current resolution: STANDARD

Standby to scan: DOCUMENT READY

2 Lift the handset and dial the number

- Use one of the dialling methods described on page 5-15.

LINE IN USE

Ex: TEL= 2 887 0166

3 If a person answers, you can converse normally. When you are ready to send the fax, ask the person to press the start button on their fax machine, or set their fax machine to receive, then press **START/COPY** on the FAX-L250 and hang up.



TX

TX/RX NO. 0012

- The LCD displays TX and the transmission number (TX/RX NO.)



Be sure to press the  (**START/COPY**) button **before** you hang up, or you will disconnect the call.

Memory Sending

Memory sending is a quick and easy way to send a fax. The FAX-L250 scans the document into its memory as it dials the fax number. If the line is free, the FAX-L250 begins sending the fax as it scans the rest of the document.

The FAX-L250 has enough memory to store up to 90 pages (fewer if the document contains many graphics or particularly dense text).

Follow the instructions below to send a document with memory sending:



Be sure to adjust the document feed lever before loading your document. See page 5-6 for details.

1 Prepare the document and load it, face down, into the Automatic Document Feeder (ADF).

- Once the document is loaded, the LCD display shows the following:
- If necessary, you can adjust the resolution and contrast. See page 5-13 for details.

Currently used memory: MEMORY USED 0%

Current resolution: STANDARD

Standby to scan: DOCUMENT READY

2 Dial the other party's fax number.

- Use one of the dialling methods described on page 5-15.
- If you must first dial a digit to get an outside line ("9", for example), add a pause after that digit by pressing the **REDIAL/PAUSE** button, as shown in the example above.

Ex: TEL= 9p5164886700

3 Press **START/COPY**.



- The FAX-L250 then begins scanning the document into memory and dials the number:

TX

After a few seconds, the display shows the number of pages it has scanned:

SCANNING P. 001

The display then shows the transaction number for the fax. This is a unique number the FAX-L250 assigns to the document, and is used to identify the document in transaction reports:

TX/RX NO. 0002

The display continues to show these three displays in order while the fax is sending.

- When the FAX-L250 finishes sending the fax, the display shows the TRANSMITTING OK message:

TRANSMITTING OK



If an error occurs during sending, the FAX-L250 will print out an error report. If this happens, try sending the fax again. See "Faxing Problems" on page 10-20 for details about errors.

Adding Pages to the Document in the Automatic Document Feeder (ADF)

The FAX-L250 Automatic Document Feeder (ADF) can hold up to 20 A4, 20 letter, or 10 legal-size pages at a time when the document feed lever is set to automatic document feed. If your document has more pages than this, you can add pages while the FAX-L250 is scanning.

1 Wait until the last sheet in the Automatic Document Feeder (ADF) starts feeding.

2 Load up to 20 additional sheets (10 legal size).

- Insert the first new page so that it overlaps the last page by about 2.5 cm.

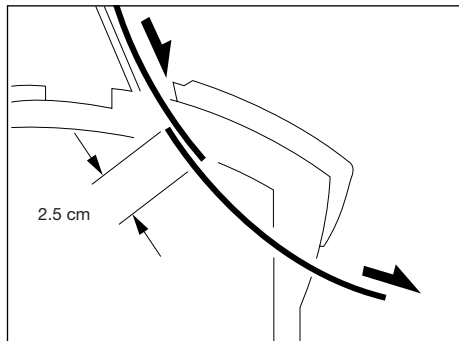

Wait until your document has been scanned completely before inserting a new document.

Cancelling Sending

If you want to stop sending before the transmission is finished, do the following.

1 Press STOP



- If you are sending manually, the transmission is cancelled immediately.
- If you are sending from memory, the following appears in the display:

CANCEL? *YES #NO

2 To cancel sending, press *:



- If you change your mind and want the unit to continue sending, press the # button. The FAX-L250 will continue sending normally.

TX/RX CANCELLED



After you cancel a fax, you may need to open the operation panel to remove the document from the Automatic Document Feeder (ADF). See "Removing the Document from the Automatic Document Feeder (ADF)" on page 5-22.

Removing the Document from the Automatic Document Feeder (ADF)

- 1** Open the operation panel by gently pulling towards you.

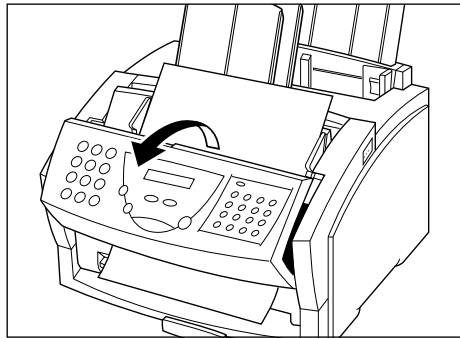

- 2** Remove the document by pulling it out from the top or bottom.

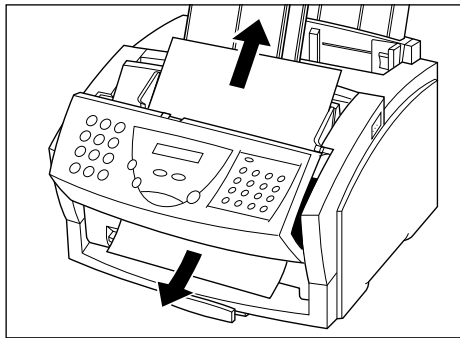

- Do not pull the document without opening the operation panel, otherwise the document will tear.

- 3** When you are finished, close the operation panel by pressing it down from the centre as shown.

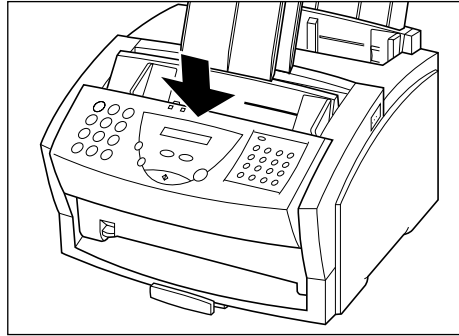

Be sure to close the operation panel until it locks into place. Otherwise the unit will not function properly.



Redialling

Manual Redialling

To redial the last number dialled with the numeric buttons, press the **REDIAL/PAUSE** button.

To cancel manual redialling, simply press the  (**STOP**) button.

Automatic Redialling with Memory Sending

With memory sending, you can set the FAX-L250 to automatically dial the fax number again if the receiving fax machine does not answer, if the line is busy, or if an error occurs during sending. You can also control how many times the FAX-L250 will redial the number, how long it will wait between dialling attempts, and how much of the fax the FAX-L250 will resend if an error occurs. See "Setting Up Automatic Redialling" on page 5-26 for more details.

When automatic redialling is in use, the FAX-L250 alternately displays **AUTO REDIAL** and the transaction number while it is waiting to redial.

AUTO REDIAL

TX/RX NO. 0013

When it begins redialling, it alternately displays **CALLING**, the transaction number, and the fax number you dialled.

CALLING

TX/RX NO. 0013

7390208

- If you used one-touch or coded speed dialling to dial the number, the name registered under that button or code will also be displayed.

If the receiving fax machine does not answer on the last attempt, the FAX-L250 displays **BUSY/NO SIGNAL** (if the unit is set not to print a report).

If this happens, try sending again later.

BUSY/NO SIGNAL

■ Cancelling Automatic Redialling

Automatic redialling cannot be cancelled with the  (**STOP**) button while the unit is waiting to redial. To cancel do the following steps.

1 Wait until the FAX-L250 begins redialling.

CALLING

- While the FAX-L250 is waiting to redial, the LCD displays **AUTO REDIAL**.

2 Press **STOP**.

- The FAX-L250 asks you to confirm that you want to cancel:



CANCEL? *YES #NO

3 To cancel the redialling, press *****.

- The FAX-L250 beeps and alternates the following displays:



TX/RX CANCELLED

TX/RX NO 0002

- The unit then prints an error report (if set to print one).

PRINTING REPORT

5

 You can also delete the document from memory. See "Deleting a Document Stored in Memory" on page 5-37.

Sending Faxes

■ Setting Up Automatic Redialling

You can set up the following for automatic redialling:









- The number of times the FAX-L250 attempts redialling
- The time interval between redialling attempts
- How the unit handles redialling when a transmission error occurs



The factory default settings for the auto redial feature are:

- The FAX-L250 redials twice.
- The FAX-L250 waits two minutes before redialling*
- If an error occurs during transmission, the FAX-L250 resends the first page of the document and the error page.

Follow the procedure below to adjust the automatic redialling settings.

- 1 Press FUNCTION.**
 
- 2 Press < or > to select TX SETTINGS.**
  
- 3 Press START/COPY, then press < or > to select AUTO REDIAL.**
   

* One minute for New Zealand

4 Press **START/COPY**, then use **<** or **>** to select **ON**.

- The default setting is **ON**.



5 Press **START/COPY**.



6 Press **START/COPY** again, then use the numeric buttons to enter the number of times you want the unit to redial (1 to 15 times*).

- The default setting is twice.

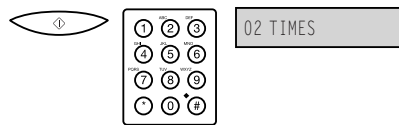

7 Press **START/COPY**.



8 Press **START/COPY** again, then use the numeric buttons to enter the time interval between rediallings. (2 to 99 minutes**)

- The default setting is two minutes***.

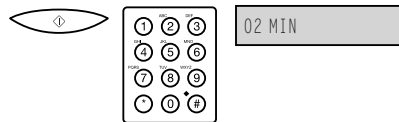

9 Press **START/COPY**.



* UK and Hong Kong: 1-3 times, Australia: 1-2 times, Ireland 1-4 times, New Zealand 1-5 times
 ** Australia, Hong Kong, Malaysia: 1-99 minutes
 *** 1 minute for New Zealand

Sending Faxes

10 Press **START/COPY** again, then use **<** or **>** to select whether or not the unit redials when a transmission error occurs.



ON
 OFF

- Select ON to redial when a transmission error occurs; select OFF to cancel redialling when a transmission error occurs.
- The default setting is ON.

11 Press **START/COPY**.



RESEND TX FROM

12 Press **START/COPY** again, then if you selected ON in step 10, use **<** or **>** to select which pages are sent when an error occurs.



Resends the first page of the document and the page where the error occurred.

ERROR & 1ST PG

Resends only the page where the error occurred.

ERROR PAGE

Resends all pages of the document.

ALL PAGES

- The default setting is ERROR & 1st PG.

13 Press **START/COPY** to save your selection, then press **STOP** to return to standby mode.



14:30 FaxOnly

Sequential Broadcasting

Sending a Document to More than One Destination

The FAX-L250's sequential broadcasting feature allows you to send a fax to a sequence of up to 117 fax numbers, using any combination of dialling methods as follows:

- One-touch speed dialling: up to 16 destinations
- Coded speed dialling: up to 100 destinations
- Regular dialling: 1 destination only
(with the numeric buttons)

You can enter the one-touch speed dialling and coded speed dialling destinations in any order. You can also include one destination that you dial manually using the numeric buttons.

To send a fax to more than one location, do the following:



Be sure to adjust the document feed lever before loading your document. See page 5-6 for details.

1 Prepare the document and load it, face down, into the Automatic Document Feeder (ADF).

- If necessary, you can adjust the resolution and contrast. See page 5-13 for details.

2 Enter up to 117 fax destinations using any of the following three methods:

- **One-touch speed dialling:**
Press the desired one-touch speed dialling button (s).

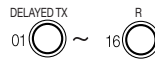

Sending Faxes

3

■ Coded speed dialling:

Press **CODED DIAL**, then enter the two-digit code (00–99) using the numeric buttons.

- Be sure to press **CODED DIAL** before each code.



■ Regular dialling:

Enter the number using the numeric buttons, then press **START/COPY**.

- You can only enter one number with the numeric buttons.



- After entering the first one-touch speed dialling button or coded speed dialling code, you have five seconds to enter another speed dialling button or code before the FAX-L250 begins sending automatically. If you have entered more than one speed dialling button or code, the FAX-L250 waits for 10 seconds before it begins sending.
- If you want to review the numbers you entered, press the **FUNCTION** button and use the < or > buttons to scroll through the numbers.

3

When you finish entering numbers, press START/COPY to begin sending, or wait a few seconds for the FAX-L250 to begin sending automatically.



- The FAX-L250 then scans the document into memory, and begins sending it to the destinations in numerical order, starting with the coded dial numbers, then the one-touch numbers, and finally the number dialled with the numeric buttons.



If the FAX-L250 memory becomes full while scanning your document, MEMORY FULL appears on the LCD display. If this happens, remove the remainder of the document from the Automatic Document Feeder (ADF) (you may need to open the operation panel to do so), then divide the document into several sections and send each section individually.

Sending a Document Using Group Dialling

If you frequently send faxes to the same group of people, you can create a "group." Groups are stored under one-touch speed dialling buttons or coded speed dialling codes. See Chapter 4, "Speed Dialling" for details on registering numbers under groups and using group dialling.

Delayed Sending

Your FAX-L250 allows you to scan a document into its memory and send it automatically at a preset time. By using this feature, you can take advantage of lower long distance rates at night, for example.



Be sure to adjust the document feed lever before loading your document. See page 5-6 for more details.

1 Prepare the document and load it, face down, into the Automatic Document Feeder (ADF).

- If necessary, you can adjust the resolution and contrast. See page 5-13 for more details.

2 Press FUNCTION, then DELAYED TX.

- The current time is displayed.

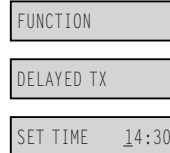

3 Use the numeric buttons to enter the time at which you want to send the document.

- Enter the time using the 24-hour clock system. Precede single digits with a zero.



Ex:

2 2 0 0



Example: 7:30 a.m. = 07:30
11:30 p.m. = 23:30

4 Press **START/COPY**.

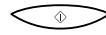

SELECT LOCATIONS

TEL=

5 Enter the destination (s) using any of the following three methods.

■ **One-touch speed dialling:**

Press the desired one-touch speed dialling button (s).



■ **Coded speed dialling:**

Press **CODED DIAL**, then enter the two-digit code (00–99) using the numeric buttons.

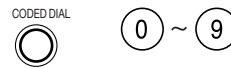

- Be sure to press **CODED DIAL** before each code.

■ **Regular dialling:**

Enter the number using the numeric buttons, then press **START/COPY**.



- You can only enter one number with the numeric buttons.

6 When you finish entering numbers, press **START/COPY**.



SCANNING P.001

- The FAX-L250 begins scanning the document into memory.

Sending Faxes



- If the FAX-L250 memory becomes full while scanning your document, MEMORY FULL appears on the LCD display. If this happens, you cannot send the document at a delayed time. See page 5-22 to remove your document from the Automatic Document Feeder (ADF).
- You can only register one preset sending operation at a time.

When the set time comes, the FAX-L250 dials and sends the document.

Sending Other Documents While the FAX-L250 is Set for Delayed Sending

The FAX-L250 is a multitasking unit, so you can send, receive, and copy other documents even when you have set the FAX-L250 for delayed sending.

To copy or send other documents after setting the FAX-L250 for delayed sending, simply follow the sending or copying procedures described in this user's guide.



Documents Stored in Memory

Documents stored in memory can be dealt with differently according to their type. The following functions can be used with documents stored in memory for delayed sending, stored when a transmission error has occurred, or with faxes received in memory.

Printing a List of Documents Stored in Memory

The FAX-L250 can print out a list of documents stored in memory, along with the transaction (TX/RX) number of each. Once you know the transaction number of a document in memory, you can resend it or delete it. These procedures are described later in this chapter.

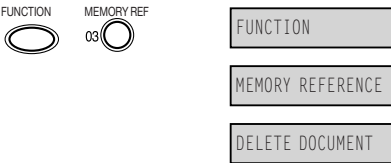
To print a list of documents stored in memory, follow this procedure.

- 1** Press **FUNCTION**, then **MEMORY REF.**

- 2** Use **<** or **>** to select **DOC. MEMORY LIST.**

- 3** Press **START/COPY.**

- The FAX-L250 begins printing a list of documents stored in memory.

5

Sending Faxes

07/09 '98 MON 15:28 FAX 81 733 3173		CANON U.K.		001	
***** *** DOC. MEMORY LIST *** *****					
TX/RX NO	MODE	CONNECTION TEL/ID	PGS.	SET TIME	ST. TIME
0001	B*CAST	[01] Canon TOKYO	3	19/02 13:50	18:00
0002	DELAYED TX	[* 00] CANON ESPAÑA	2	19/02 13:52	23:30
0003	TRANSMIT	[01] Canon TOKYO	1	19/02 14:23	18:00

Deleting a Document Stored in Memory

Follow this procedure to delete a document from memory.

- 1** Press **FUNCTION**, then **MEMORY REF**.

FUNCTION



MEMORY REF



FUNCTION

MEMORY REFERENCE

DELETE DOCUMENT

- 2** Press **START/COPY**.



TX/RX NO. 001

- 3** Use **<** or **>** to select the **TX/RX** number of the document you want to delete.

10



12



TX/RX NO. 003

 - If you are not sure of the TX/RX number of the document you want to delete, print the list of documents stored in memory. See page 5-35 for details.

- 4** Press **START/COPY**.



YES=(*) NO=(#)

- 5** Press ***** to delete the fax, or **#** to cancel deleting.





 - If you press #, the unit returns to step 3.

- 6** Press **STOP** to return to standby mode.



14:30 FaxOnly

Resending a Document that Encountered an Error

If you get an error signal when sending a document from memory, you can try resending the document to the same destination without having to scan it again.



- Make sure that the **ERASE FAILED TX** setting in the **TX SETTINGS** is set to OFF. See page 12-9 for details on changing the setting.
- When the **AUTO REDIAL** setting in the **TX SETTINGS** is set to OFF, a document that failed to be sent is also considered an error document.

1 Press **FUNCTION**, then **MEMORY REF.**



FUNCTION

MEMORY REFERENCE

DELETE DOCUMENT

2 Use **< or >** to select **MEM. RETRANSMIT.**



MEM. RETRANSMIT

3 Press **START/COPY.**



TX/RX NO. 0001

4 Use **or** to select the **TX/RX number of the document you want to resend.**



TX/RX NO 0003

- If you are not sure of the TX/RX number of the document you want to resend, print the list of documents stored in memory. See page 5-35 for details.

5 Press **START/COPY**.



DIALLING



The document is erased from memory after it is successfully sent.



Sending with the Password/Subaddress Feature

Some fax machines will only receive faxes from other fax machines if they are sent using a password and subaddress that correspond to the password and subaddress of the receiving fax machine. This feature allows you to enter the password/subaddress (based on the ITU-T standard) of the receiving fax before sending the document.



Make sure you have the other party's password and subaddress. The password and subaddress you enter must be identical to those of the receiving fax.

To send a document with a password and subaddress, follow this procedure.



Be sure to adjust the document feed lever before loading your document. See page 5-6 for more details.

1 Prepare the document and load it, face down, into the Automatic Document Feeder (ADF).

- If necessary, you can adjust the resolution and contrast. See page 5-13 for more details.

2 Press FUNCTION, then PWD/SUBADD.

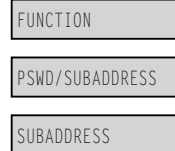

Sending with the Password/Subaddress Feature

3 Press **START/COPY**, then use the numeric buttons to enter the subaddress.

- The subaddress can be up to 20 digits long.

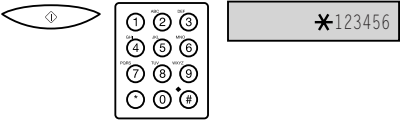

4 Press **START/COPY**.

- If the other party does not register the password, you must not enter a password. In this case, use the < or > button to select **SELECT LOCATIONS**, press the ⬆ (START/COPY) button and go to step 7.



5 Press **START/COPY** again, then use the numeric buttons to enter the password.

- The password can be up to 20 digits long.

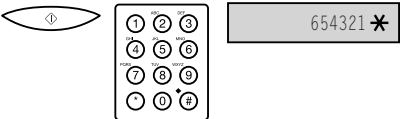

6 Press **START/COPY** twice.



7 Enter the destination (s) using any of the following three methods.

■ **One-touch speed dialling:**

Press **FUNCTION**, then press the desired one-touch speed dialling button (s).

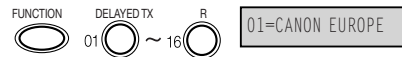

■ **Coded speed dialling:**

Press **CODED DIAL**, then enter the two-digit code (00-99) using the numeric buttons.

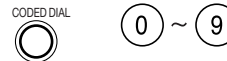

- Be sure to press **CODED DIAL** before each code.

■ **Regular dialling:**

Enter the number using the numeric buttons, then press **START/COPY**.



- You can only enter one number with the numeric buttons.

8 Press **START/COPY**.



- The FAX-L250 begins scanning the document.



If a Power Cut Occurs



If power to the FAX-L250 is cut off, any documents stored in its fax memory will be lost. (The FAX-L250 automatically prints a list of the lost documents when power is restored.) Because of this, you should be sure to print documents stored in memory or resend them as soon as possible.

While power is out, you can only use the FAX-L250 to receive telephone calls (if you have a telephone connected to the unit). You cannot make calls, or send or receive faxes.

This page is intentionally blank.

6

Receiving Faxes

This chapter describes how to use your FAX-L250 to receive faxes.

Different Ways to Receive a Fax	6-2
Setting the Receive Mode	6-3
Receiving Faxes and Phone Calls Automatically:	
Fax/Tel Mode	6-4
Setting Up Fax/Tel Mode	6-4
What Happens When Fax/Tel Mode is Selected	6-6
Receiving Faxes Manually: MANUAL MODE	6-9
Receiving Faxes Automatically: FAX ONLY MODE	6-10
Using an Answering Machine: ANS.MACHINE	
MODE	6-11
Using the FAX-L250 with an Answering Machine ..	6-11
Network FAX/TEL Switching (Australia Only)	6-12
Setting the FAX-L250 for Network Switch	6-12
Network Switch System Operation	6-13
Network FAX/TEL Switching (New Zealand Only)	6-14
Setting the FAX-L250 for Network Switch	6-14
Network Switch System Operation	6-15
Documents Received in Memory	6-16
Messages Displayed When Documents are Received	
in Memory	6-16
Printing Documents Received in Memory	6-17
Receiving while Registering, Copying, or Printing	6-17
Cancelling an Incoming Fax	6-18
Polling to Receive Faxes	6-19
Polling a Fax Machine	6-19



Different Ways to Receive a Fax



The FAX-L250 provides you with four different modes for receiving faxes. To decide which mode will best suit your requirements, consider how you want to use the FAX-L250:

■ **Fax/Tel Mode**

Use this mode if you will occasionally use the FAX-L250 as a telephone. In this mode, if an incoming call is a fax, the FAX-L250 then receives fax calls automatically, without ringing; if the call is from a person, the FAX-L250 rings to alert you to pick up the optional handset or telephone to answer the call. This mode is economical, in that it allows you to have phone and fax service without the expense of an additional phone line.

This mode also includes settings that let you control precisely how it handles incoming calls. For details see page 6-4.

■ **MANUAL MODE**

Use this mode if you will frequently use the FAX-L250 as a telephone and want to answer every call yourself, including fax calls. The FAX-L250 then rings for every call, whether phone or fax, and you must press the \diamond (**START/COPY**) button to begin receiving a fax.

■ **FAX ONLY MODE**

Use this mode if the FAX-L250 will be connected to a separate telephone line used only for transmitting faxes. The FAX-L250 then answers all calls, and receives all faxes automatically.

■ **ANS.MACHINE MODE**

Use this mode if you plan to connect an answering machine to the FAX-L250 to receive faxes and phone messages. The FAX-L250 then receives incoming faxes normally, and routes incoming phone calls to the answering machine.

Once you have decided which mode you want, set the mode as described in "Setting the Receive Mode" on page 6-3. You can change the mode at any time.

Setting the Receive Mode

Set the FAX-L250 receive mode as follows:

1 Press **RECEIVE MODE**.



FAX ONLY MODE

- The LCD display shows the current receive mode setting.

2 If you want to change the receive mode, press **RECEIVE MODE** until the mode you want appears.



ANS. MACHINE MODE

Fax/Tel Mode

MANUAL MODE

FAX ONLY MODE

- After about five seconds, the FAX-L250 returns to standby mode and displays the time and the new receive mode:

14:30 AnsMode

14:30 FaxTel

14:30 Manual

14:30 FaxOnly

Receiving Faxes and Phone Calls Automatically: Fax/Tel Mode

See page 6-3 to select Fax/Tel Mode.

Set this mode if you want your FAX-L250 to automatically switch between voice and fax calls. For this mode, you need to have the optional handset or a telephone connected to your unit.

You can control precisely how your FAX-L250 handles incoming calls by adjusting the settings described below.

■ Setting Up Fax/Tel Mode

When you select Fax/Tel Mode, you can also set these options.

■ RING START TIME

When a call comes in, the unit checks to see if it is a person wishing to speak to you or a fax machine trying to send a document. If your unit does not have enough time to detect the fax tone, it assumes the call is from a telephone. Use the RING START TIME setting to increase the time the unit takes to check whether a call is from a fax machine or a telephone. You can select a time between 0 and 30 seconds; the default is 8 seconds.

■ F/T RING TIME

When your unit is set to receive both fax and telephone calls automatically, it rings to alert you to pick up the handset if the call is from a person. If you do not pick up the handset within a certain amount of time, the unit stops ringing. Use this option to change the number of times the unit rings, from 1 to 300 seconds. The default is 22 seconds.

■ F/T SWITCH ACTION

Not all fax machines are capable of sending a FAX TONE (the CNG tone that warns the receiving fax machine that a fax is coming). For those cases the unit may think that the call coming in is a voice call and rings to alert you of the call (the amount of time it is going to ring is determined by the F/T RING TIME setting above). If you do not answer the call, one of two things can happen:

Different Ways to Receive a Fax

- 1 If you set the F/T SWITCH ACTION to RECEIVE, the unit will switch to fax receive mode automatically at that point and start to receive the document. If no document comes in, it disconnects the call after approximately 35 seconds. The factory default setting is RECEIVE.
- 2 If you set the F/T SWITCH ACTION to DISCONNECT, the unit will disconnect the phone call immediately freeing up your phone line at this point.

■ What Happens When Fax/Tel Mode is Selected

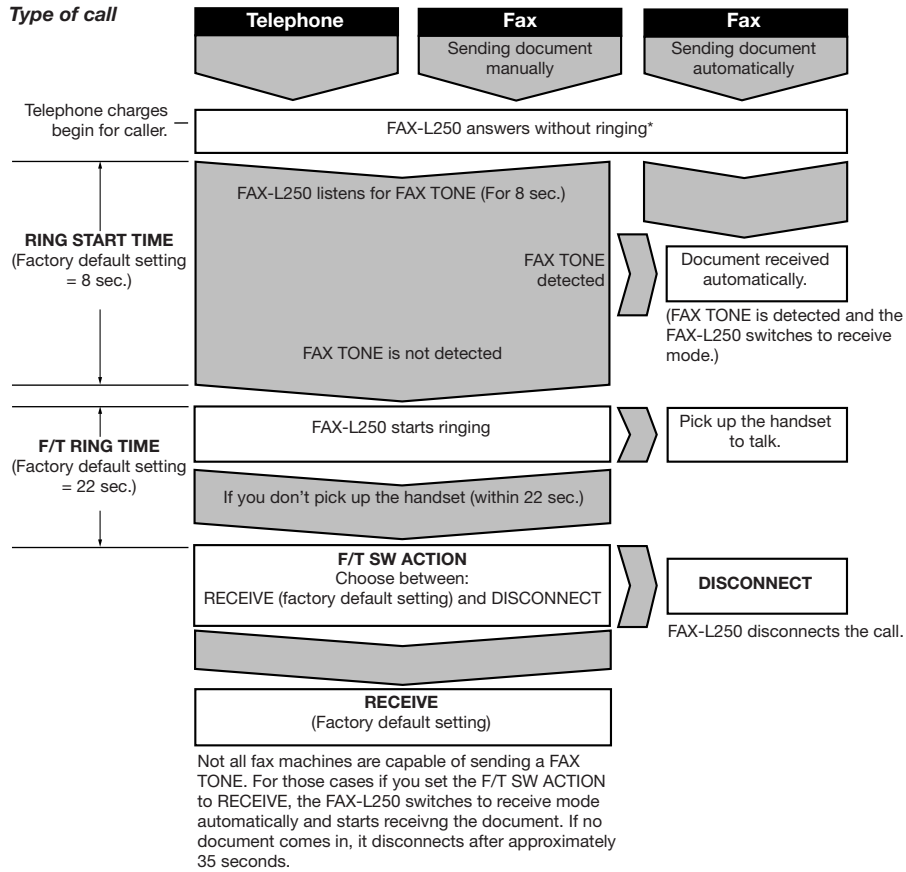



















* In Australia, the fax plays "You are connected. Please hold." after answering.















You can select these options in the RX MODE submenu of the RX SETTINGS menu when Fax/Tel Mode is selected. See below for details on changing the settings.

Different Ways to Receive a Fax

X Set the Fax/Tel Mode options as follows:

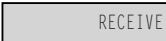
- 1** Press **FUNCTION**.
 
- 2** Use **<** or **>** to select **RX SETTINGS**.
  
- 3** Press **START/COPY**, then use **<** or **>** to select **RX MODE**.
   
- 4** Press **START/COPY**, then use **<** or **>** to select **Fax/Tel Mode**.
   
- 5** Press **START/COPY**.
 
- 6** Press **START/COPY** again, then use the numeric buttons to enter a time between 0 and 30 seconds.
  
 - This setting determines how many seconds the unit waits before ringing when it receives a call.
 - The factory default setting is 8 seconds.

Receiving Faxes

- 7** Press **START/COPY**.  
- 8** Press **START/COPY** again, then use the numeric buttons to enter a time between 1 and 300 seconds.   
- This setting determines how many seconds the unit rings while waiting for someone to pick up the handset.
 - The factory default setting is 22 seconds.
- 9** Press **START/COPY**.  
- 10** Press **START/COPY** again, then use **<** or **>** to select **RECEIVE** or **DISCONNECT**.     or 
- This setting tells the unit what to do if no one picks up the handset within the specified ring time set in step 8.
 - Select **RECEIVE** to receive the call, and **DISCONNECT** to disconnect the call.
- 11** Press **START/COPY**, then press **STOP** to return to standby mode.   

Receiving Faxes Manually: MANUAL MODE

See page 6-3 to select MANUAL MODE.

To use this feature, you must have the optional handset or a telephone connected to the FAX-L250. See "Connecting the Optional Handset, a Telephone or Answering Machine" on page 2-15. In MANUAL MODE, the FAX-L250 rings every time it receives a call, whether the call is from a telephone or a fax machine.

If you use your FAX-L250 with MANUAL MODE, answer incoming calls as follows:

1 When the FAX-L250 or the telephone rings, pick up the handset.

If you hear a person's voice:

2 Start your conversation. If the caller wants to send a document after talking to you, ask them to press the start button on their fax machine. When you hear a slow beep, press START/COPY to begin receiving the document.



If you hear a slow beep or silence:

2 A fax machine is trying to send you a document.

Press **START/COPY** on the FAX-L250, then hang up.



-or-

Enter the two-digit ID code from the telephone, then hang up.

Ex: (2) (5)

- The FAX-L250 then begins receiving the document. (This is particularly convenient if your telephone is located away from the FAX-L250.)
- If you do not hang up after pressing the two-digit ID code, the unit beeps intermittently for a few seconds after you receive the document. (You can turn the beeping off by disabling the **OFFHOOK ALARM** in the **USER SETTINGS** menu. See page 12-5 for details).

Receiving Faxes



If you have an answering machine connected to your FAX-L250 that can carry out remote-control operations (controlling your answering machine from a remote telephone), the security code for this function may be the same as the two-digit ID code described above. If so, make sure you change the FAX-L250 two-digit ID code to make it distinct from the answering machine's security code. See page 12-11 for more details.

Receiving Faxes Automatically: FAX ONLY MODE

When the FAX-L250 is set up for a dedicated line, set **FAX ONLY MODE** to automatically receive documents whenever a call comes over the fax line.

1 Make sure the FAX-L250 is set up to receive over a dedicated fax line.

2 Press **RECEIVE MODE** to select **FAX ONLY MODE**.



- The FAX-L250 assumes all incoming calls are from fax machines sending documents. It receives documents automatically and disconnects all voice calls.

Using an Answering Machine: ANS.MACHINE MODE

See page 6-3 to select ANS.MACHINE MODE.

Connecting an answering machine to the FAX-L250 allows you to receive faxes and phone messages while you are out of the office.

In ANS.MACHINE MODE, the FAX-L250 allows the answering machine to answer incoming calls, then listens for a fax tone or for four seconds of silence (also an indication that a fax is coming in), and automatically receives the fax if it detects the fax tone or a four-second silence.

For instructions on connecting an answering machine to the

FAX-L250, see "Connecting the Optional Handset, a Telephone, or Answering Machine" on page 2-15.



Canon does not recommend using an "answering service" (like those offered by local telephone companies that provide voice mail) on the telephone line you are connecting to the FAX-L250. If you do subscribe to an answering service, you may want to dedicate a separate line for fax communication only and connect that line to the FAX-L250.

■ Using the FAX-L250 with an Answering Machine

Follow these guidelines when using the FAX-L250 with an answering machine:

- Set the answering machine to answer on the first or second ring.
- If the FAX-L250 runs out of paper or toner in ANS.MACHINE MODE, it receives all faxes into memory. The faxes then print automatically when you add paper or replace the toner cartridge.
- When recording the outgoing message on the answering machine:
 - Leave a four-second pause at the beginning of the message.
 - The entire message, including the four-second pause, must be no more than 15 seconds long.
 - In the message, tell your callers how to send a fax. For example:

"Hello. I can't answer the phone right now, but please leave a message after the beep. I'll return your call as soon as possible. If you would like to send a fax, press the start button on your fax machine after you leave your message. Thank you."

Network FAX/TEL Switching (Australia Only)

Telstra offers the FaxStream DUET capability. If you subscribe to this service, your line is assigned two numbers: one for fax and one for phone. When the fax number is called, the network sends a specific ringing tone which your unit recognises and automatically handles as a fax call. If the phone number is called, a different ringing tone is sent out from the network so that the call is handled as a voice call. This means that there is no switching delay at the caller's end.













- Triple ring (short-short-short) for fax receiving.
Three short rings, at regular intervals.
- Any ring except triple ring (depending on your switchboard) for telephone conversation



When you select **NET. SWITCH** from the **RX MODE** setting in the **RX SETTINGS** menu, the receive mode will be locked on Fax/Tel Mode. You will be unable to change the receive mode with the **RECEIVE MODE** button.

■ Setting the FAX-L250 for Network Switch

Follow these steps to select **NET. SWITCH**.

- 1 Press FUNCTION.**
 
- 2 Use < or > to select RX SETTINGS.**
  
- 3 Press START/COPY, then use < or > to select RX MODE.**
   
- 4 Press START/COPY, then use < or > to select NET. SWITCH.**
   

- 5** Press **START/COPY**, then press **STOP** to return to standby mode.



14:30 FaxTel

■ Network Switch System Operation

The procedure for using the network switch system is almost the same as when using the unit over a normal telephone line. When you receive calls, however, the unit will respond slightly differently as described below.

When you hear the telephone call ring pattern:

Pick up the handset and talk normally. If you hear a slow beep, it means the call is from a fax machine trying to send a document. Press the  (**START/COPY**) button to receive the document. If you do not pick up the handset, the unit continues to ring until the other party hangs up. If an answering machine is connected, it takes over the call.

When you hear the fax call ring pattern (triple ring):

After the unit rings, it receives the document automatically.

If you want to receive a document without a ringing sound:

Make sure that the **INCOMING RING** setting is set to **OFF**. See page 12-11 for details.

Network FAX/TEL Switching (New Zealand Only)













Telecom N.Z. offers the FaxAbility capability. If you subscribe to this service, your line is assigned two numbers: one for fax and one for phone. When the fax number is called, the network sends a specific ringing tone which your unit recognises and automatically handles as a fax call. If the phone number is called, a different ringing tone is sent out from the network so that the call is handled as a voice call. This means that there is no switching delay at the caller's end.



When you select **NET. SWITCH** from the **RX MODE** setting in the **RX SETTINGS** menu, the receive mode will be locked on Fax/Tel Mode. You will be unable to change the receive mode with the **RECEIVE MODE** button.

■ Setting the FAX-L250 for Network Switch

Follow these steps to select **NET. SWITCH**.

- 1** Press **FUNCTION**.
 
- 2** Use **<** or **>** to select **RX SETTINGS**.
  
- 3** Press **START/COPY**, then use **<** or **>** to select **RX MODE**.
   
- 4** Press **START/COPY**, then use **<** or **>** to select **NET. SWITCH**.
   

- 5** Press **START/COPY**, then press **STOP** to return to standby mode.



14:30 FaxTel

■ Network Switch System Operation

The procedure for using the network switch system is almost the same as when using the unit over a normal telephone line. When you receive calls, however, the unit will respond slightly differently as described below.

When you hear the telephone call ring pattern:

Pick up the handset and talk normally. If you hear a slow beep, it means the call is from a fax machine trying to send a document. Press the  (**START/COPY**) button to receive the document. If you do not pick up the handset, the unit continues to ring until the other party hangs up. If an answering machine is connected, it takes over the call.

When you hear the fax call ring pattern (triple ring):

After the unit rings, it receives the document automatically.

If you want to receive a document without a ringing sound:

Make sure that the **INCOMING RING** setting is set to **OFF**. See page 12-11 for details.



Documents Received in Memory

The FAX-L250 will automatically receive incoming faxes into its memory if it encounters a problem that prevents it from printing normally. The LCD will display a message showing the problem. See below for correcting the problem.



The FAX-L250 memory can store up to approximately 90 A4-size pages.

Messages Displayed When Documents are Received in Memory

If the FAX-L250 receives a document into its memory, the LCD displays one of the following messages. These messages show the action you must take to correct the problem.

CHANGE CARTRIDGE

Cause: The toner cartridge ran out of toner or is not installed properly.
Action: Make sure the cartridge is installed properly, and install a new one if necessary. See "Installing/Replacing the Toner Cartridge" on page 2-27.

CHECK COVER/CART

Cause: There is no toner cartridge in the FAX-L250, or the front cover is open.
Action: Close the front cover or install a toner cartridge. See "Installing/Replacing the Toner Cartridge" on page 2-27.

Documents Received in Memory

LOAD PAPER

Cause: The FAX-L250 ran out of paper.
Action: Add paper to the sheet feeder. See "Loading Recording Paper" on page 2-33.

CLEAR PAPER JAM

Cause: A paper jam occurred.
Action: Clear the jam, then press the ⏹ (STOP) button. See "Paper Jams" on page 10-5.

Printing Documents Received in Memory

When the problem shown on the LCD display is corrected (see above), the FAX-L250 automatically prints the faxes it has stored in memory. Once the faxes are printed, the FAX-L250 deletes them from memory.



Receiving While Registering, Copying, or Printing

Since the FAX-L250 is a multitasking device, it can receive faxes and phone calls while you are entering your user information, making copies, or printing a report.

If you receive a fax while you are making copies or printing a report manually, the FAX-L250 stores the incoming fax in memory. Then, as soon as you finish making copies or printing the report, the FAX-L250 automatically prints the fax. If you are entering registration information, the fax is printed as soon as it is received, and does not go into memory.

Canceling an Incoming Fax

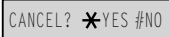
To cancel an incoming fax, follow this procedure:

- 1** Press **STOP**.  
- 2** Press ***** to stop receiving, or **#** to resume receiving the fax.  

Polling to Receive Faxes

The FAX-L250's polling feature allows you to request a document to be faxed to you from another fax machine. The sender only needs to make sure the document is on his fax machine and ready to be sent: when your FAX-L250 polls that machine, the document is sent automatically. The FAX-L250 can poll any fax machine that supports polling. (This process does not work in reverse, however: the FAX-L250 cannot be polled by other fax machines.)

Polling a fax machine

To poll another fax machine and receive a document from it, do the following:



- Before attempting to poll a fax machine, make sure that fax machine supports polling.
- Your FAX-L250 cannot be polled by another fax machine.

1 Lift the handset and dial the fax number of the fax machine you wish to poll.

- Use one of the dialling methods described on page 5-15.

LINE IN USE

TEL= 2 887 0166

2 When you hear a beep, press **START/COPY**, then hang up.



The FAX-L250 begins receiving the fax.



If the sender is using a Canon fax machine which has the Polling ID function, ask him to set the Polling ID of his fax machine to 255 (**1111 1111** binary number).

For details on the Polling ID, refer to the sender's fax machine manual. In all other cases the Polling ID is not a concern.

6

This page is intentionally blank

7

Special Features

This chapter describes the special features of the FAX-L250.

Special Dialling	7-2
Dialling Through a Switchboard	7-2
Registering the Access Type and Outside Line Access Number under the R Button	7-2
Long Distance Dialling	7-4
How to Enter Pauses	7-4
Confirming a Dial Tone	7-5
Using Tone Dialling on a Pulse Line	7-6
Restricting Use of the FAX-L250	7-7
Using Alternative Telephone Networks (UK Only)	7-9
Attaching the M Label	7-9
Registering an Alternative Telephone Network	7-10
Sending with an Alternative Telephone Network	7-12
Registering Speed Dialling with the M Button	7-13

Special Dialling

This section explains special dialling features, such as dialling through a switchboard and dialling international numbers.



Dialling Through a Switchboard

A PBX (Private Branch Exchange) is an on-site telephone switchboard. If your FAX-L250 is connected through a PBX or other telephone switching system, you have to dial the outside line access number first, and then dial the number of the party you are calling.

You can register the type of access and the outside line access number under the **R** button, so that you only have to press the **FUNCTION** and **R** buttons before dialling the number you wish to reach. Follow the instructions below to register the **R** button.

■ Registering the Access Type and the Outside Line Access Number under the **R** button

Follow these steps to register the access type and the outside line access number under the **R** button.

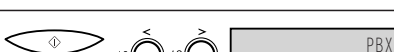
- 1 Press FUNCTION.**

- 2 Use < or > to select USER SETTINGS.**

- 3 Press START/COPY, then use < or > to display R-KEY SETTING.**

- 4 Press START/COPY, then use < or > to select PBX.**

5 Press **START/COPY**, then use **<** or **>** to select the access line type for the switching system.*

* Users in Australia cannot select **EARTH CONNECTION**.

6 Press **START/COPY**.

If you selected **PREFIX** in step 5

7 Press **START/COPY**, then use the numeric buttons to enter the outside line access number (up to 20 digits).

8 Press **REDIAL/PAUSE**.

9 Press **START/COPY**, then press **STOP** to return to standby mode.

If you selected **EARTH CONNECTION** or **HOOKING** in step 5

7 Press **START/COPY**, then press **STOP** to return to standby mode.

Long Distance Dialling

When you register a long distance number, you may have to insert a pause either within or after the number. For long distance dialling, the location and length of the pause may differ depending on the telephone system.

■ How to Enter Pauses

Use this procedure to enter pauses within or at the end of numbers.

- 1** During dialling registration, when you come to a step that asks you to enter a number for dialling, use the numeric buttons to enter the number.



- 2** To enter a pause within a number, press REDIAL/PAUSE.

REDIAL/PAUSE



- To enter a pause at the end of a number, press the REDIAL/PAUSE button and then press the \diamond (START/COPY) button.
- A pause entered within a number (P) is two seconds long.*
- If necessary, you can adjust the length of a pause within a number. See page 12-9 for more details.
- To make a longer pause within a number, press the REDIAL/PAUSE button again. Each pause adds two seconds to the length of the pause.**
- A pause at the end of a number (P) is fixed to ten seconds.

* 4 seconds long in the UK and Hong Kong

** Users in the UK can only enter one pause between digits in the tel/fax numbers.

Confirming a Dial Tone*

Use this feature only when you register a number. In some areas you may have to confirm the dial tone in the middle of the facsimile number before dialling the rest of the number. This is called dial tone detection.

- 1** Use the numeric buttons to enter the first part of the number until dial tone detection is required.

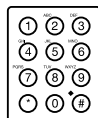

TEL= 348

- 2** When a dial tone detection is required, press **FUNCTION**, then press **D.T.**

- Where the dial tone is inserted, you will see a small dot. During dialling this is where the unit waits for the dial tone.



TEL=348•

- 3** Enter the remainder of the number.

* This feature is ineffective in the UK, Hong Kong, Australia, New Zealand, Singapore, and Malaysia.

Using Tone Dialling on a Pulse Line

Even if you have a pulse line, the FAX-L250 enables you to use tone dialling once you have connected to the number you are calling. This lets you take advantage of many services that require tones, such as selecting options from telephone "touch-line" services.

- 1 Pick up the handset and dial the number using the numeric buttons.**

- The unit connects using the pulses required by your phone line.

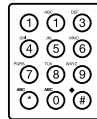

- 2 Press FUNCTION, then press TONE/+ to switch to tone dialling.**

- When the TONE/+ button is pressed, T is displayed in the LCD.
- Numbers entered after pressing the TONE/+ button will be dialled using tone dialling.



- 3 When you have finished, hang up the handset.**



When registering one-touch speed dialling and coded speed dialling numbers, if you enter the **TONE/+** button after the number, you will switch to tone dialling after the phone connection is made.

Example:

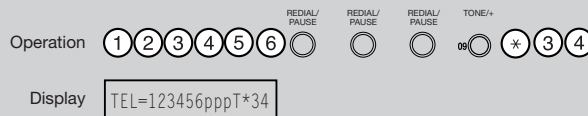









After the number (123456) is dialled, it will pause for 6 seconds (**ppp**) to allow the other party to answer and then it will switch to tone (T). Now you can follow the instructions that were recorded by the party you called.

Restricting Use of the FAX-L250

If you do not want unauthorised people to be able to make calls or send documents, set the **LOCK PHONE** feature to ON.

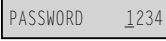
To restrict access to the **LOCK PHONE** option, you need to register a password. Set the password and **LOCK PHONE** option as follows:

- 1** Press **FUNCTION**.
 
- 2** Use **< or >** to select **SYSTEM SETTINGS**.
 
- 3** Press **START/COPY** twice.
 - If a password has already been registered, enter it now, then press the **START/COPY** button. 

- 4** Press **START/COPY**.
 - If a password is already registered, it will be displayed: Ex: 
 - If a password is not registered, the following is displayed: 

Special Features

5 To register or change the current password, enter four numbers, then press **START/COPY**.

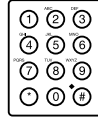
- or -



Ex:

PASSWORD 4321

To keep the current password, press **START/COPY**.



6 Press **START/COPY**, then use **<** or **>** to set **LOCK PHONE** on or off.



- The default setting is OFF. Anyone can send documents or dial normally.
- When set to ON, no one can make calls or send documents. Does not restrict incoming calls/faxes.

OFF

ON

7 Press **START/COPY**, then press **STOP** to return to standby mode.



14:30 Manual

Using Alternative Telephone Networks (UK only)

The FAX-L250 has a built-in feature that allows you to send documents and make telephone calls with an alternative long-distance service, such as the 2300 Service of Mercury Communications Limited. If you subscribe to such a service, you can save money on most long distance international communications.







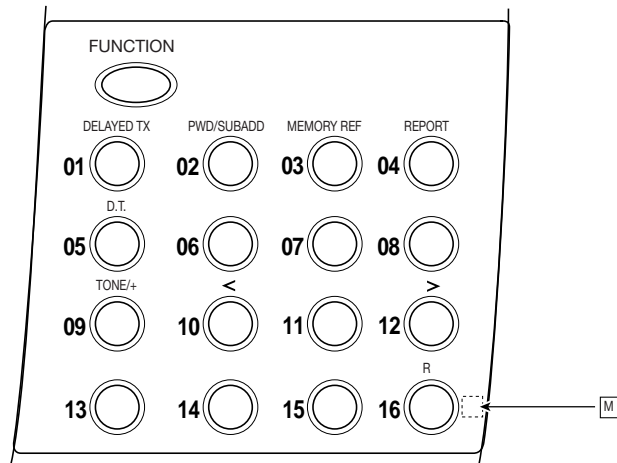











The procedures described in this section show you how to use your unit with the 2300 Service of Mercury Communications Limited. For details on using your unit with alternative telephone services, contact your Canon authorised representative.

Attaching the M Label

Before operating the unit, attach the M label to help you identify the button as shown below.



Registering an Alternative Telephone Network

- 1** Press **FUNCTION**.
 
- 2** Use **<** or **>** to select **USER SETTINGS**.
  
- 3** Press **START/COPY**, then use **<** or **>** to select **M-KEY SETTING**.
   
- 4** Press **START/COPY**, then use **or** to select **ON**.
   
- 5** Press **START/COPY**.
 
- 6** Press **START/COPY** again, then use **<** or **>** to select the access code.
   

- You can select 132 (default) or 131P ("P" stands for a four-second pause).

7 Press **START/COPY**



If you selected 131P in step 6:

8 Press **START/COPY** again, then use the numeric buttons to enter the ID code.

- This code is given to you by Mercury Telecommunications Limited.
- Your code can be up to 20 digits long (pauses are unnecessary).
- If an ID code is already registered, you will see a string of asterisks (* * * * *) on the display.



Ex:

ID CODE

123456789

9 Press **START/COPY**, then press **STOP** to return to standby mode.



14:30 Manual

If you selected 132 in step 6:

8 Press **STOP** to return to standby mode.



14:30 Manual

Sending with an Alternative Telephone Network



Be sure to adjust the document feed lever before loading your document. See page 5-6 for details.

1 Prepare the document and load it, face down, into the Automatic Document Feeder (ADF).

- If necessary, you can adjust the resolution and contrast. See page 5-13 for details.

2 Press M.



TEL= M

3 Use the numeric buttons to enter the facsimile or telephone number of the party you are calling.

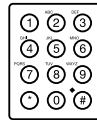

Ex: TEL= M416795111

4 Press START/COPY.



- The FAX-L250 automatically dials the access code and ID code registered under the **M** button. Next, the unit dials the number of the party you are calling and connects the call.



- In order to protect your codes, the access code and ID code are not printed on activity reports.
- If **M-KEY SETTING** is set to ON, the button 16 cannot be used for one-touch speed dialling. If you attempt to register a number for one-touch speed dialling under this button, "**M-KEY**" will be displayed.

Registering Speed Dialling with the M Button

When registering numbers for one-touch or coded speed dialling, you can also register your access code and ID code. This allows you to send documents or make calls over the 2300 Service of Mercury Communications Limited at the press of one or a few buttons.



You must first register the access code and ID code under the **M** button before you can register them under speed dialling numbers.

- 1** While you are registering a number for one-touch or coded speed dialling, and you come to a step that asks you to enter the number of the other party, press **FUNCTION**, then press **M**.



TEL= M

- 2** Use the numeric buttons to enter the number.

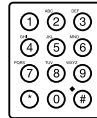

Ex:

TEL= M773 3173

- 3** Continue with the procedure for registering one-touch or coded speed dialling numbers.

Once you have registered the **M** button with the numbers under speed dialling numbers, you can dial and use the 2300 Service without pressing the **M** button.

This page is intentionally blank.

8

Making Copies

This chapter describes how to make copies with your FAX-L250.

Making Copies 8-2

Making Copies

One of the FAX-L250's convenient features is its ability to make up to 99 high-quality copies of a document. To make copies, do the following:



Be sure to adjust the document feed lever before loading your document. See page 5-6 for details.

1 Prepare the document and load it, face down, into the Automatic Document Feeder (ADF).

- Once the document is loaded, the LCD display shows the following:

Currently used memory: MEMORY USED 0%

Current resolution for fax sending: FINE

Standby to scan: DOCUMENT READY

2 Press START/COPY.

- The display now shows **COPY**, the reduction size the copy will be printed at (the default is 100%), and the number of copies (the default is 1).



COPY 100% 01

3 To set the copying resolution, press RESOLUTION and select the setting you want.

RESOLUTION



(FINE resolution with halftone)

FINE



PHOTO

 ■ You cannot make copies in **STANDARD** resolution, but must use **FINE** or **PHOTO** resolution instead. (**STANDARD** does not appear as one of the available resolutions.)

■ **FINE** resolution works well for copying most text documents.

■ Use **PHOTO** resolution when copying documents that contain photographs. This scans areas of the document that contain photos with 64 levels of grey, and results in a much better reproduction of the photograph.

4 If you want to reduce the size of the copies, use < or > to select the reduction percentage you want.

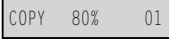

Ex: 

■ You can select 70%, 80%, 90%, or 100%.

5 If you want to make multiple copies, use the numeric buttons to enter the number of copies.



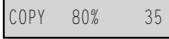

Ex: 

■ You can make up to 99 copies.

 The FAX-L250 copies at 600 × 300 dpi for single copies, and at 300 × 300 dpi for multiple copies. For high resolution copying, make one copy at a time.

6 Press **START/COPY** to begin copying.





■ To stop copying, press the  (**STOP**) button. You may then need to lift the operation panel to remove the document. See "Jams in the Automatic Document Feeder (ADF)" on page 10-5.

Making Copies

- If an error occurs during copying, the message **START AGAIN** appears in the display, and you will need to reload the document and start copying again.



If **MEMORY FULL** appears in the display while you are making multiple copies of a document, you will not be able to use the multiple copy feature for copying the document. Instead, make single copies of the document (as many times as required). To correct this situation, delete or resend any documents stored in memory. See "Documents Stored in Memory" on page 5-35.

9

Reports and Lists

This chapter describes how to print reports and lists. These include activity reports (transmission and reception reports), lists of registered numbers, list of user's data registered in the FAX-L250 and the memory clear list.

Activity Report	9-2
Transmission (TX) Reports	9-3
Error TX Report	9-3
TX Report	9-4
Multi TX/RX Report	9-5
Reception (RX) Report	9-6
Memory Clear Report	9-7
User's Data List	9-8
Speed Dialling Lists	9-10
One-Touch Speed Dial List	9-11
Coded Speed Dial List	9-11
Group Dial List	9-11

Activity Report

The Activity Report is printed out automatically by the FAX-L250 after every 20 sending and receiving transactions. This report lists the details of the faxes you have sent or received so that you can keep track of the transaction operations your FAX-L250 has performed.

You can also print the Activity Report manually if you want to check the report before the 20 transactions are completed. Follow this procedure to print the Activity Report.

1 Press **FUNCTION**.



FUNCTION

2 Press **REPORT**.



PRINTING REPORT

07/09 '98 MON 15:00 FAX 81 733 3173							CANON U.K.		001	
***** *** ACTIVITY REPORT *** *****										
ST. TIME	CONNECTION TEL	CONNECTION ID	NO.	MODE		PGS.	RESULT			
'08/09 13:43	905 795 1111	Canon Canada	5001	AUTO FAX RX	ECM	1	OK	00'33		
'08/09 13:45	905 795 1111	Canon Canada	5002	AUTO FAX RX	ECM	1	OK	00'24		
'08/09 13:51	1 49 39 25 25	Canon FRANCE	0001	B' CAST	ECM	3	OK	01'18		
'08/09 14:31	2131 1250	CANON DEUTSCH.	0004	TRANSMIT	ECM	1	OK	00'24		
'08/09 14:34	905 795 1111	CANON CANADA	5003	AUTO FAX RX	ECM	1	OK	00'18		
'08/09 14:36	516 488 6700	CANON U.S.A.	5004	AUTO FAX RX	ECM	4	OK	00'59		
'08/09 14:41	20 545 8545	CANON Europa NV	0005	TRANSMIT	ECM	1	NG	01'20		
						1				
'08/09 14:45	20 545 8545	CANON Europa NV	0005	TRANSMIT	ECM	1	OK	04'12		
'08/09 14:53	03 3756 6112	Canon Tokyo	5005	AUTO FAX RX	ECM	1	NG	01'16		
						4				
'08/09 14:57	2131 1250	CANON DEUTSCH.	0006	TRANSMIT	ECM	3	NG	00'51		
						3		STOP		
'08/09 14:59	1 538 4500	CANON ESPAÑA	0007	TRANSMIT	G3	0	NG	00'01		
	456#123 * #					0		#081		

SUBADDRESS ———
 TRANSACTION NUMBER ———
 SENDING MODE ———
 TRANSACTION VIA ERROR CORRECTION MODE ———
 THE NUMBER OF THE PAGE WITH AN ERROR ———
 ERROR CODE: DESCRIBES THE NATURE OF THE ERROR ———
 (STOP) WAS PRESSED DURING TRANSACTION ———

IF MARKED WITH AN ASTERISK, THE ENTRY HAS APPEARED ON A PREVIOUS REPORT.

Transmission (TX) Reports

The FAX-L250 normally prints a report only when an error occurs during sending (TX Error Report). However, you can set the FAX-L250 to print a report every time you send a document (TX Report).

If you send a document using memory, you can also select whether the first page of the document is printed with the report.

See page 12-7 for details on setting these options.

Error TX Report

07/09 '98 mon 14:59 fax 81 733 3173	CANON U.K.	001
***** *** ERROR TX REPORT *** *****		
TXFUNCTION WAS NOT COMPLETED		
TX/RX NO	0003	
CONNECTION TEL		1 538 4500
CONNECTION ID	CANON ESPAÑA	
ST. TIME	10/01 20:58	
USAGE T	00'04	
PGS.	0	#081

- See the next page for an explanation of the report.

RESULT **OK** means that all pages were transmitted either during the first attempt or after the first or second retry. (The default, which is two retries, can be changed. See page 12-9 for more details.)

NG means that either some or no pages were transmitted after two retries. (The default, which is two retries, can be changed. See page 12-9 for more details.)

Multi TX/RX Report

If you used sequential broadcasting to send a document, the Multi TX/RX Report is printed.

07/09 '98 MON 14:59 FAX 81 733 3173	CANON U.K.	001
***** *** MULTI TX/RX REPORT *** *****		
TX/RXNO	0007	
INCOMPLETE TX/RX	[01] 03 3758 2111	Canon TOKYO
TRANSACTION OK	[02] 906 795 1111	CANON CANADA
ERROR		

Reception (RX) Report

Normally the FAX-L250 does not print a reception report (RX Report) unless you set it to do so.

You can set the FAX-L250 to print the RX Report every time you receive a document or only if an error occurs during receiving. See page 12-7 for details on setting this option.

07/09 '98 MON 14:38 FAX 81 733 3173	CANON U.K.	001
***** *** RX REPORT *** *****		
RECEPTION OK		
TX/RX NO	5004	
CONNECTION TEL		516 488 6700
SUBADDRESS		
CONNECTION ID	CANON U.S.A.	
ST. TIME	19/02 14:36	
USAGE T	00'59	
PGS.	4	
RESULT		OK

Memory Clear Report

If you experience a power failure, all documents stored in memory will be lost. As soon as power is restored, the FAX-L250 will automatically print a list of documents that were stored in memory before the power failure.

07/09 '98 MON 15:28 FAX 81 733 3173		CANON U.K.		001	
***** *** MEMORY CLEAR REPORT *** ***** MEMORY FILES DELETED					
TX/RX.NO	MODE	CONNECTION TEL/ID	PGS.	SET TIME	ST. TIME
0001	B' CAST	[01] Canon TOKYO	3	08/09 13:50	18:00
0002	DELAYED TX	[00] CANON ESPAÑA	2	08/09 13:52	23:30
0003	TRANSMIT	[01] Canon TOKYO	1	08/09 14:23	18:00











If there is no paper in the sheet feeder when the power is cut off, the LCD will display **LOAD PAPER** and **PRINTING REPORT** when the power is restored. If this happens, load paper in the sheet feeder and wait for the unit to print the Memory Clear Report. You will be unable to send documents or receive faxes in memory until you do this. If you have no paper available and you urgently need to send a document or receive a fax in memory, press the **(STOP)** button to enable sending and receiving. However, please note that once you have pressed the **(STOP)** button the unit will no longer print the Memory Clear Report.

User's Data List

You can print a list of the data registered in your FAX-L250. This list is useful when you want to review the user data information you may have entered (such as your name and number, the date and time) and all other settings currently selected.

Follow this procedure to print the User's Data List.

- 1** Press **FUNCTION**.
 
- 2** Use **<** or **>** to select **USER SETTINGS**.
  
- 3** Press **START/COPY**, then **REPORT**.
  

07/09 '98 MON 14:49 FAX 81 733 3173	CANON U.K.	001









EC-03-01 /02	***	USER'S DATA LIST

USER SETTINGS		
UNIT TELEPHONE #		81 733 3173
UNIT NAME	CANON U.K.	
TX TERMINAL ID	ON	
TTI POSITION		OUTSIDE IMAGE
TELEPHONE # MARK		FAX
AUTO HALFTONE	ON	
SCANNING CONTRAST	STANDARD	
OFFHOOK ALARM	ON	
VOLUME CONTROL		
CALLING VOLUME	VOL MID	
KEYPAD VOLUME	VOL MID	
ALARM VOLUME	VOL MID	
RX CALL LEVEL	STANDARD	
TEL LINE TYPE	ROTARY PULSE	
SYSTEM SETTINGS		
UN/LOCK PHONE		
LOCK PHONE	OFF	OFF
RX RESTRICTION	OFF	
DATA FORMAT	DD/MM YY	
DISPLAY LANGUAGE	ENGLISH	
TX START SPEED	14400bps	
RX START SPEED	14400bps	
TOTAL FAX MEMORY		0.656MByte

Speed Dialling Lists

Your FAX-L250 can print speed dialling lists. These lists allow you to review the numbers and names registered under one-touch speed dialling buttons and coded speed dialling codes.

Follow this procedure to print the lists.

- 1** Press **FUNCTION**.
 
- 2** Use **<** or **>** to select **TEL REGISTRATION**.
  
- 3** Press **START/COPY**.
 
- 4** Press **REPORT**.
 

One-Touch Speed Dial List

07/09 '98 MON 13:38 FAX 81 733 3173		CANON U.K.		001
***** *** 1-TOUCH SPD DIAL LIST *** *****				
NO.	CONNECTION TEL	CONNECTION ID		
[01]	03 3758 2111	Canon TOKYO		
[02]	905 795 1111	CANON CANADA		
[03]	20 545 8545	CANON Europa NV		
[04]	1 49 39 25 25	CANON FRANCE		
[05]	GROUP DIAL	CANON GROUP-1		

Coded Speed Dial List

07/09 '98 MON 13:39 FAX 81 733 3173		CANON U.K.		001
***** *** CODED SPEED DIAL LIST *** *****				
NO.	CONNECTION TEL	CONNECTION ID		
[* 00]	1 538 4500	CANON ESPAÑA		
[* 11]	7390802	CANON HONG KONG		
[* 60]	63 9399	Mr. G. Robert		
[* 61]	03 3756 6112	Ms. A. Smith		

Group Dial List

07/09 '98 MON 13:39 FAX 81 733 3173		CANON U.K.		001
***** *** GROUP DIAL LIST *** *****				
[05] CANON GROUP-1	[01] 03 3758 2111	Canon TOKYO		
	[02] 905 795 1111	CANON CANADA		
	[03] 20 545 8545	CANON Europa NV		
	[04] 1 49 39 25 25	Canon FRANCE		
[08] GROUP-02	[06] 516p488 6700	Canon U.S.A.		
	[07] 2131 1250	CANON DEUTSCH.		

This page is intentionally blank.

10

Frequently Asked Questions

If your FAX-L250 is not operating properly, use the information and suggestions in this chapter to try to solve the problem.

If You Cannot Solve the Problem	10-2
Problems Index	10-3
Paper Jams	10-5
Jams in the Automatic Document Feeder (ADF)? ..	10-5
Jams in the Output Slots?	10-8
Jams Inside the Unit?	10-9
Jams in the Front Area of the Unit?	10-14
After Clearing a Paper Jam	10-17
Problems Feeding Paper Into the FAX-L250 Sheet Feeder	10-18
Faxing Problems	10-20
Sending Faxes	10-20
Receiving Faxes	10-22
Telephone Problems	10-26
Copying Problems	10-26
Printing Problems	10-27
Print Quality Problems	10-28
General Problems	10-29
Error Codes, Messages, and Solutions	10-30



Problems Index



Problem	See page
Paper Jams	
Jams in the Automatic Document Feeder (ADF)?	10-5
Jams in the Output Slots?	10-8
Jams inside the Unit?	10-9
Jams in the Front Area of the Unit?	10-14
Problems Feeding Paper Into the FAX-L250 Sheet Feeder	
Paper does not feed into the FAX-L250?	10-18
Printing is skewed?	10-18
Several sheets load into the FAX-L250 at once?	10-19
The paper jams repeatedly?	10-19
Faxing Problems	
Cannot send a fax?	10-20
Images on faxes received from the FAX-L250 are spotted or dirty?	10-21
The FAX-L250 cannot send a fax using ECM?	10-21
Errors occur frequently while sending faxes?	10-22
The FAX-L250 cannot receive faxes automatically?	10-22
The FAX-L250 will not switch between telephone and fax calls automatically?	10-23
The FAX-L250 will not receive faxes manually?	10-23
The print quality is poor?	10-24
The FAX-L250 cannot receive faxes using ECM?	10-24
Nothing prints?	10-24
Received faxes are blotched or uneven?	10-25
Errors occur frequently while receiving?	10-25
Telephone Problems	
The FAX-L250 cannot dial?	10-26
The phone disconnects while you are talking on the line?	10-26
Copying Problems	
The FAX-L250 will not make a copy?	10-26
MEMORY FULL appears in the LCD display when you are making multiple copies?	10-26

Frequently Asked Questions

Problem	See page
Printing Problems	
The ALARM lamp comes on and the FAX-L250 beeps while printing?	10-27
Nothing prints?	10-27
Printout does not match paper size?	10-27
The printout curls?	10-27
Print Quality Problems	
Print is not clear?	10-28
The printout has vertical white streaks?	10-28
General Problems	
The FAX-L250 has no power?	10-29
Nothing appears in the LCD display?	10-29

Paper Jams

On occasion, the document feeding into the FAX-L250 Automatic Document Feeder (ADF) or the paper in its sheet feeder may misfeed or jam. If this happens, you can usually fix the problem using one of the following procedures.



You do not need to unplug the FAX-L250 while clearing paper jams.

■ Jams in the Automatic Document Feeder (ADF)?

Use this procedure if the document in the FAX-L250's Automatic Document Feeder (ADF) jams or misfeeds. (If this occurs, the message CHECK DOCUMENT appears in the display.)

1 Press STOP.



Do not try to pull the document out without opening the operation panel, or you may tear or smudge the document.

2 Open the operation panel by gently pulling it towards you.

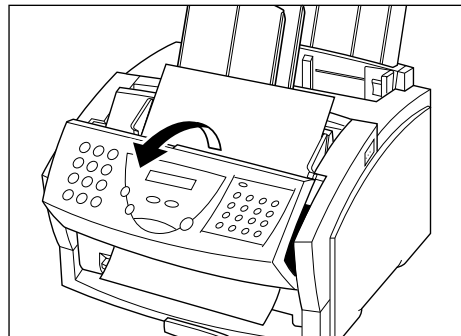

Frequently Asked Questions

- 3** Remove the jammed page by pulling it in either direction.

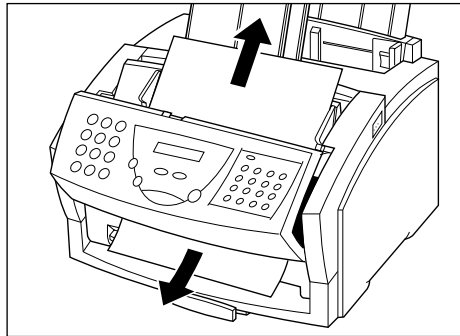

If the paper does not pull out easily, do not force it. Contact your local authorised Canon dealer or service centre.

- 4** When you are finished, close the operation panel by pressing it down from the centre as shown.

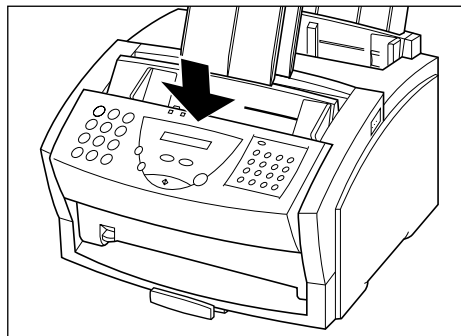

Be sure to close the operation panel until it locks into place. Otherwise the unit will not function properly.

5 Press STOP to clear the error message.



6 If you have a multi-page document, remove the entire document from the Automatic Document Feeder (ADF), and reload it.

Frequently Asked Questions

■ Jams in the Output Slots?

Use this procedure if the recording paper jams or misfeeds in the output slots. If this happens, the message CLEAR PAPER JAM appears in the LCD display.

- 1** Gently pull any jammed paper out of the unit as shown.

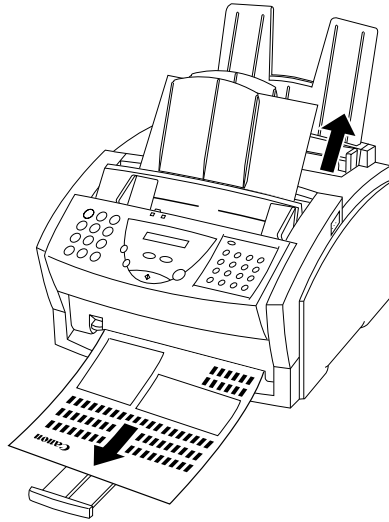

- 2** Remove the paper stack from the sheet feeder and reload it, following the instructions in "Loading Recording Paper" on page 2-33.



If the paper jam occurred while a fax was being received into the FAX-L250 memory, that fax will print automatically when the jam is cleared.

■ Jams Inside the Unit?

1 Open the front cover by pressing the release latches on the sides of the unit.

- Lift the cover forward to its open position.

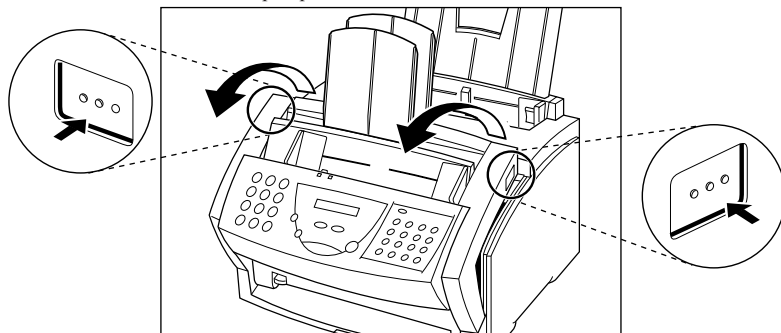

Do not open the front cover without pressing on the release latches as this may cause damage to your unit.

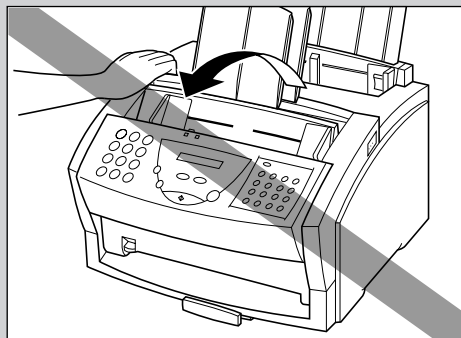

Frequently Asked Questions

2 Hold the cartridge by its handle and remove it from the unit.

- Cover the cartridge to protect it from the light.

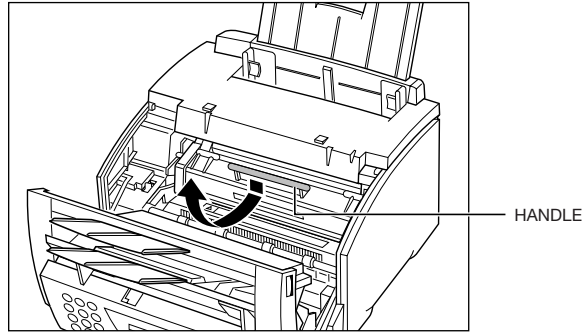

3 Move the paper release lever towards the back of the unit.

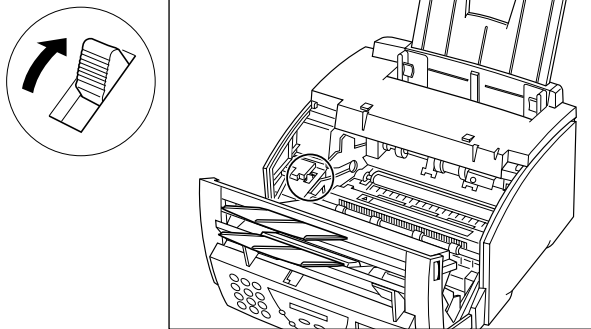

4 Locate the jammed piece of paper.

- First check the inside of the unit and then the front area.

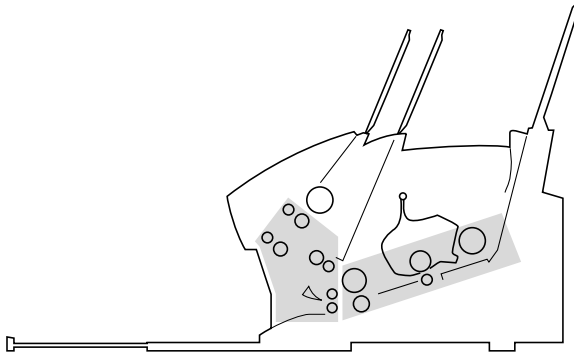

The fixing assembly (shaded) becomes extremely hot when the unit is in use. Be very careful not to touch it, as injury may result.



CAUTION: HOT SURFACE AVOID CONTACT ACHTUNG! HEISS ATTENTION: TEMPERATURE ELEVÉE
PRECAUCIÓN/ATTENZIONE! ALTA TEMPERATURA 注意高温 注意高温

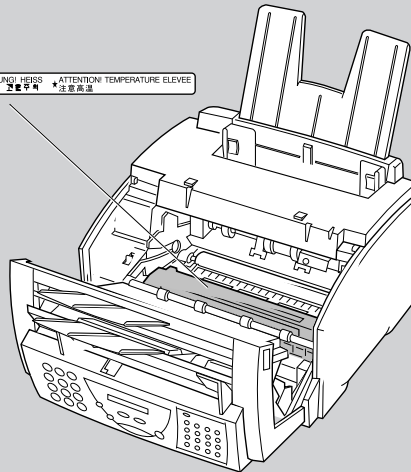

Frequently Asked Questions

If the paper has jammed near the sheet feeder slot

Hold the unit steady and pull the jammed paper straight out from the unit.

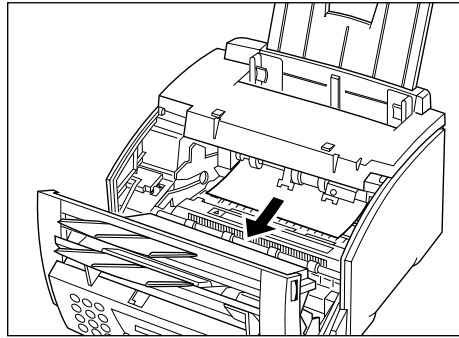

- Do not tear jammed paper. If the sheet tears, remove all of the paper scraps from the unit.
- Be careful not to spill the toner that is on the jammed sheet of paper. The toner has not been fused to the paper yet, and toner spilled inside the unit may adversely affect the print quality.
- Be careful not to get toner on your hands or clothing. If you do, wash it off immediately with cold water.

If the top edge of the paper is in the fixing assembly

First move the jammed paper towards the unit (1); then pull it towards you to remove it (2).

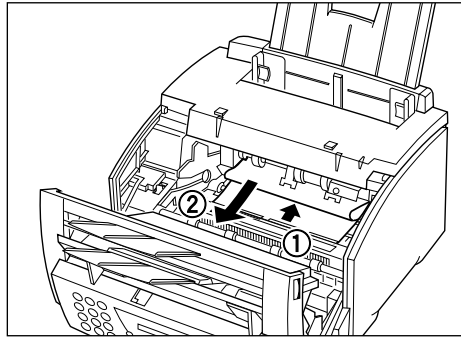

Frequently Asked Questions

■ **Jams in the Front Area of the Unit?**

If the top edge of the paper has passed through the fixing assembly

- 1** Pass the paper under the roller as shown.

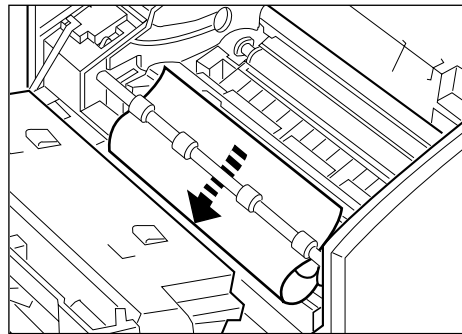

- 2** Use both hands to carefully pull the jammed paper.

- Be sure to pull gently, otherwise the paper may tear and remain inside the unit.
- Be sure to remove all the jammed paper. Not doing so will cause paper to jam again.

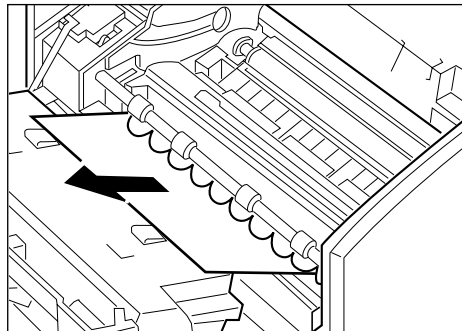

If the paper has jammed near the face-up delivery slot

Hold the front cover and gently pull the sheet through the exit slot.

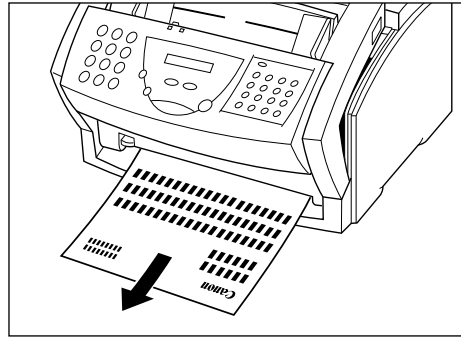

Do not close the front cover while removing a jammed sheet of paper. This will return the paper release lever to its closed position.

Frequently Asked Questions

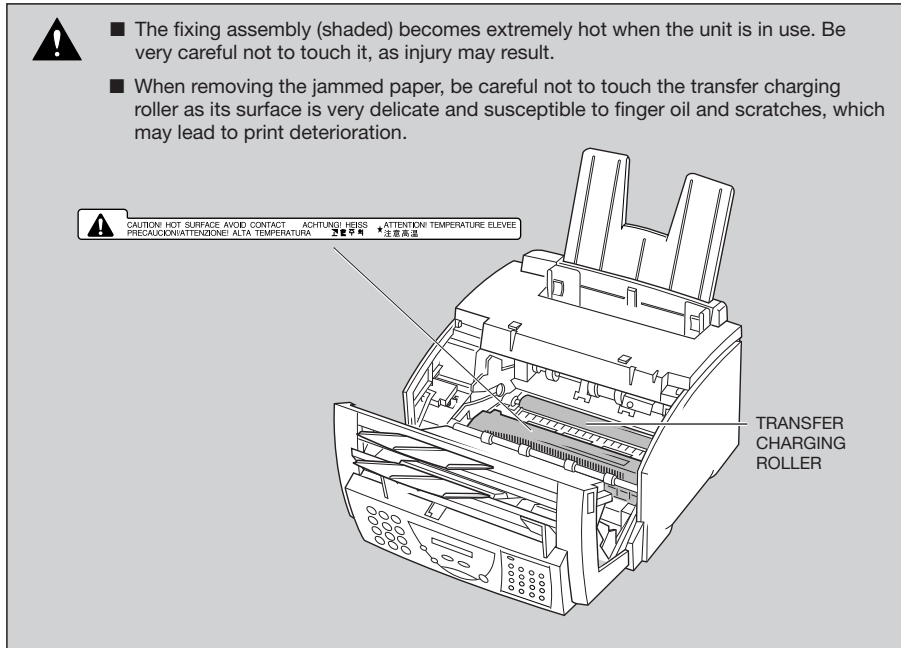

■ After Clearing a Jam

After removing the jammed paper, follow these steps:

- 1** _____
Install the FX-3 toner cartridge back in the unit.
- 2** _____
Move the paper release lever back to its original position (towards the front).
- 3** _____
Close the front cover to reset the unit.
- 4** _____
Load paper in the sheet feeder.



If you are experiencing repeated paper jams, it may be due to the paper you are using:

- Tap the paper on a flat surface before stacking it in the sheet feeder.
- Check that the paper you are using and your printing environment are within the specifications of the unit. See Appendix A, "Specifications".

Problems Feeding Paper Into the FAX-L250 Sheet Feeder

If you are having problems feeding paper into the FAX-L250's sheet feeder, check the following table.



Whenever you correct one of these problems, be sure to remove the paper from the sheet feeder and load it again. See page 2-33.

The following problems can also cause the paper to jam in the unit. See page 10-5 for instructions on clearing paper jams.

Problem	Possible cause	Solution
Paper does not feed into the FAX-L250?	The sheet feeder may contain too many sheets.	Make sure the sheet feeder is not filled past the limit. See page 2-33.
	Paper may not be inserted in the sheet feeder correctly.	Make sure paper is inserted all the way into the sheet feeder. See page 2-33.
Printing is skewed?	Paper may not be stacked correctly in the sheet feeder.	Make sure the stack of paper is straight in the sheet feeder.
		Make sure there are no gaps between the stack of paper and the paper guides. See page 2-33.
		Make sure the paper exit path is clear.

Problems Index

Problem	Possible cause	Solution
Several sheets load into the FAX-L250 at once?	Paper may not be loaded in the sheet feeder correctly.	Make sure paper is inserted correctly in the sheet feeder. See page 2-33.
	Sheets of paper may be sticking together.	Make sure the paper is not sticking together. Be sure to fan the stack of paper before placing it in the sheet feeder.
	The sheet feeder may contain too many sheets.	Make sure the sheet feeder is not filled past the limit. Do not force the stack into the sheet feeder.
	The sheet feeder may contain more than one type of paper.	Load only one type of paper at a time. Make sure the paper you use meets the specifications for media in Appendix A, "Specifications". Let the paper run out before you refill the sheet feeder. Avoid mixing new paper with paper remaining in the sheet feeder.
<hr/>		
The paper jams repeatedly?	The paper itself may be causing the jams.	Fan the paper before stacking it in the sheet feeder. This keeps the sheets from sticking together. Make sure the paper you are using and your printing environment meet the specifications given in Appendix A, "Specifications".

Faxing Problems

Use the following tables to solve problems that can occur when sending and receiving faxes with the FAX-L250.

■ Sending Faxes

Problem	Possible cause	Solution
Cannot send a fax?	The FAX-L250 may have overheated and shut itself down.	If you suspect this, unplug the FAX-L250 and let it cool for several minutes, then try sending again.
	The FAX-L250 may not be set for the type of telephone line you have (pulse/tone).	Make sure the FAX-L250 is set for the type of phone line you have. See Chapter 3. (If you are not sure what type of line you have, contact your local telephone company.)
	The document may not have been set in the Automatic Document Feeder (ADF) properly.	Remove the document, stack it, and feed it into the Automatic Document Feeder (ADF) again.
	The one-touch or coded speed dialling number you used may not be registered for the feature you are using.	Check the content of the one-touch or coded speed dialling button and make sure it was registered correctly.
	The receiving fax machine may be out of paper.	Call the other party and make sure they have paper in their fax machine.
	The FAX-L250 may be sending another document from memory.	Allow time for the current document to finish sending.

Problem	Possible cause	Solution
Cannot send a fax? (continued)	An error may have occurred during sending.	Print an activity report and check for an error code.
	There may be a problem with the telephone line.	Make sure you have a dial tone on the optional handset or telephone. If not, contact your local telephone company.
	The receiving fax machine may not be a G3 fax machine.	Make sure the receiving fax machine is compatible with the FAX-L250 (which is a G3 fax machine).

 If none of the above solve the problem, try unplugging the FAX-L250 for at least five seconds, then plugging it back in. If the problem persists, contact your local authorised Canon dealer or service centre. Please note that any documents stored in memory will be erased when the FAX-L250 is unplugged.

Images on faxes received from the FAX-L250 are spotted or dirty?	The receiving fax machine may not be working properly.	Check the FAX-L250 by making a copy. If the image is clear, the problem may be in the receiving fax machine.
	The document may not be properly inserted in the Automatic Document Feeder (ADF).	Remove the document and feed it correctly into the Automatic Document Feeder (ADF).
The FAX-L250 cannot send a fax using ECM? (ECM TX does not appear in the LCD display when sending)	The receiving fax machine may not support ECM.	If the receiving fax does not support ECM, then the FAX-L250 sends the fax in normal mode without error checking.

Frequently Asked Questions

Problem	Possible cause	Solution
The FAX-L250 cannot send a fax using ECM? (continued)	ECM receiving on the receiving fax machine may not be turned on.	If the receiving fax does support ECM reception, call the other party and have them check if ECM reception is turned on.
Errors occur frequently while sending faxes?	The phone line may be in poor condition, or you may have a poor connection.	Lower the speed at which the unit starts sending faxes in the TX START SPEED menu setting. See page 12-15.

■ Receiving Faxes

Problem	Possible cause	Solution
The FAX-L250 cannot receive faxes automatically?	The FAX-L250 may not be set to receive automatically.	For the FAX-L250 to receive faxes automatically, it must be in FAX ONLY MODE, ANS.MACHINE MODE, or Fax/Tel Mode. See page 6-3.
	The FAX-L250 may have a document in memory, leaving very little or no memory available	Print out any documents stored in memory. See page 6-17.
	An error may have occurred during reception.	Check the LCD display for an error message. See page 10-30 for a listing of the FAX-L250's error messages. Print an activity report and look for an error code.
	The sheet feeder may be empty.	Make sure the sheet feeder has paper in it.
	The telephone line may not be connected properly.	Make sure all phone line connections are secure.

Problem	Possible cause	Solution
The FAX-L250 will not switch between telephone and fax calls automatically?	The FAX-L250 may not be in Fax/Tel Mode.	For the FAX-L250 to switch automatically between telephone and fax calls, it must be in Fax/Tel Mode. See page 6-3.
	The FAX-L250 may have a document in memory.	Print out any documents stored in memory. See page 6-17.
	An error may have occurred during reception.	Check the LCD display for an error message. See page 10-30 for a listing of the FAX-L250's error messages. Print an activity report and look for an error code.
	The sheet feeder may be empty.	Make sure the sheet feeder has paper in it.
	The sending fax machine may not send the CNG signal that tells the FAX-L250 that the incoming signal is a fax.	In such cases, you will have to receive the document manually. See page 6-9.
The FAX-L250 will not receive faxes manually?	You may not have pressed the Ⓢ (START/COPY) button before hanging up the handset.	Always press the Ⓢ (START/COPY) button before hanging up the handset. If you hang up before pressing the Ⓢ (START/COPY) button you will disconnect the call.

Frequently Asked Questions

Problem	Possible cause	Solution
The print quality is poor?	You may not be using the correct paper.	Make sure the paper in the sheet feeder meets the specifications given in Appendix A.
	The sending fax machine may not be operating properly.	Make a copy with your FAX-L250. If the copy looks alright, then your FAX-L250 is operating properly. Contact the sender and have them check their fax machine.



Also see "Printing Problems" on page 10-27.

The FAX-L250 cannot receive faxes using ECM? (ECM RX does not appear in the LCD display when receiving)	The sending fax machine may not support ECM.	If the sending fax does not support ECM, then the FAX-L250 receives the fax in normal mode without error checking.
	ECM reception may not be turned on.	Make sure the FAX-L250 has its ECM RX setting turned on.

Nothing prints?	The toner cartridge may not have been installed properly.	Make sure the toner cartridge is installed correctly. See page 2-27.
	The toner cartridge may need to be replaced.	See page 2-27.

Problems Index

Problem	Possible cause	Solution
Received faxes are blotched or uneven?	The telephone lines may be in poor condition, or you may have a bad connection.	Use ECM receiving to try to eliminate such problems. However, if the telephone lines are in poor condition, you may need to have the fax sent again.
	The sending fax machine may not be functioning properly.	The sending fax machine usually determines the fax's quality. Call the sender and have them make sure the top cover and scanning glass on their fax machine are clean.
Errors occur frequently while receiving?	The telephone lines may be in poor condition, or you may have a bad connection.	Lower the speed at which the unit receives faxes in the RX START SPEED setting. See page 12-15.

Frequently Asked Questions

Telephone Problems

Problem	Possible cause	Solution
The FAX-L250 cannot dial?	The telephone line may not be connected properly.	Make sure the telephone line is securely connected to the FAX-L250. See page 2-14.
	The FAX-L250 may not be set for the type of telephone line you have (pulse/tone).	Make sure the FAX-L250 is set for the type of phone you have. See Chapter 3. (If you are not sure what type of line you have, contact your local telephone company.)
The phone disconnects while you are talking on the line?	The FAX-L250 may not be plugged in properly.	Make sure the FAX-L250 is correctly plugged into a wall outlet.

Copying Problems

Problem	Cause	Solution
The FAX-L250 will not make a copy?	The document may not be placed in the document feeder correctly.	Make sure the document you are copying is set in the Automatic Document Feeder (ADF) properly, and the LCD display shows DOCUMENT READY .
	The handset may be off its hook.	Make sure the handset is on its cradle.
MEMORY FULL appears in the LCD display when you are making multiple copies?	The FAX-L250's memory is full.	Print out any received faxes stored in memory, then start making copies again. See page 6-17.

Printing Problems

If you are having problems printing with the FAX-L250, check the problems and solutions listed in the following table.

Problem	Possible cause	Solution
The ALARM lamp comes on and the FAX-L250 beeps while printing?	The FAX-L250 may have a paper jam.	Clear any paper jams as described earlier in this chapter. If the FAX-L250 has no paper jam, unplug it, wait five seconds, then plug it in again. If the problem is fixed, the ALARM lamp will be off, and the LCD display will show the time and receiving mode (standby mode). If the ALARM lamp stays on, call your local authorised Canon dealer or service centre.
Nothing prints?	The power cord may not be plugged in securely. The toner cartridge may need to be replaced.	Make sure the power cord is plugged securely into the unit and into a wall outlet. Replace the toner cartridge. See page 2-27.
Printout does not match paper size?	Paper may not be loaded and aligned correctly in the sheet feeder.	Make sure the paper is loaded correctly. See page 2-33.
The printout curls?	Your pages may include a large amount of toner.	Remove the printout as soon as it exits the FAX-L250 and let it dry, then roll it in the direction opposite of the curl.

Frequently Asked Questions

Print Quality Problems

If your print quality is not what you expect it to be, check the problems and solutions below.

Problem	Possible cause	Solution
Print is not clear?	You may be printing on the wrong side of the paper.	Many types of paper have a "correct" side for printing. If your paper does, make sure that side is facing up. If the paper has no obvious correct side, try turning the paper over and printing on the other side.
The printout has vertical white streaks?	Toner may be low or be unevenly distributed.	Follow these steps: <ol style="list-style-type: none">1. Open the front cover and take out the FX-3 toner cartridge.2. Gently rock the cartridge side to side five or six times to evenly distribute the toner inside.3. Put the cartridge back into the unit.4. Close the front cover and try to print again. If this does not solve the problem, replace the FX-3 cartridge.

General Problems

Problem	Cause	Solution
The FAX-L250 has no power?	The power cord may not be securely plugged into the unit.	Make sure the power cord is plugged securely into the unit and into a wall outlet. If the power cord is connected to a power strip, make sure the strip is connected to an outlet and turned on.
	The power cord may not be supplying power.	Check the power cord by substituting another, or by using a voltametre to test it for continuity.
Nothing appears in the LCD display?	The FAX-L250 may not be receiving power.	Check the plug and be sure it is firmly plugged into the power connector and the wall outlet. If the display remains blank, unplug the FAX-L250, wait five seconds, then plug it in again. If the display still remains blank, call your local authorised Canon dealer or service centre.

Error Codes, Messages, and Solutions

This table lists the error messages that appear in the FAX-L250 LCD display and the corresponding error codes that appear in activity reports, and tells what to do for each.

Message	Error Code	Cause	Action
AUTO REDIAL	-	The receiving fax machine was busy and the FAX-L250 is waiting to redial.	-
BUSY/NO SIGNAL	#005/018	The telephone number you dialed is busy.	Try sending the document again later.
		The other party's fax machine is not working properly.	Contact the other party and have them check their fax machine.
		The other party is not using a G3 fax machine.	Contact the other party and have them send or receive the document using a G3 machine.
		The telephone line type setting on your FAX-L250 is incorrect.	Set your FAX-L250 for your telephone line (tone or pulse).
		The receiving fax machine did not answer within 35 seconds.	Contact the other party and have them check their fax machine. You can also try to send the document manually. For an overseas call, add pauses to the registered number.
CALLING	-	The FAX-L250 is dialling the receiving fax machine.	If you want to cancel the transmission, press the  (STOP) button.
CHANGE CARTRIDGE	-	The toner cartridge is empty.	Make a copy of a document. If the printout is light or blank, replace the toner cartridge. The documents received in memory will then be printed automatically.
		The FAX-L250 image memory may be full because the toner cartridge ran out of toner.	Replace the toner cartridge and have the other party send the fax again.

Error Codes, Messages, and Solutions

Message	Error Code	Cause	Action
CHECK COVER/CART	-	The toner cartridge is not installed properly.	Make sure the toner cartridge is installed properly.
		The front cover is open.	Close the front cover.
CHECK DOCUMENT	#001	A document is jammed in the Automatic Document Feeder (ADF).	Remove the document you are trying to send or copy and load it again.
CHECK PAPER SIZE	-	The size of the paper in the sheet feeder differs from that specified in the FAX PRINTER menu setting.	Set the correct paper size in the FAX PRINTER menu setting.
CHECK PRINTER	-	The toner cartridge in the FAX-L250 is defective.	<ol style="list-style-type: none">1. Reinstall the cartridge.2. Unplug the FAX-L250, wait five seconds, then plug it in again. If the display does not change, call for service.
		The unit is connected to an uninterruptible power supply (UPS).	Make sure the power cord is plugged into an AC outlet.
CLEAR PAPER JAM	#009	The FAX-L250 has no paper in its sheet feeder, or has a paper jam.	Add paper or clear the jam. If a document was received in memory, the fax prints the received documents from memory.
COMMUNICATING PLEASE WAIT	-	You tried to use manual sending via the handset while the fax was sending from memory.	Wait until the fax is sent and try again, or use memory sending.
DOC TOO LONG	#003	It took more than 32 minutes to send or copy a document.	Divide the document and send or copy each part separately.
		It took more than 32 minutes to receive a document.	Contact the sender, and have them divide the document and send each part separately.
		The document is longer than 1 metre.	Use a copier to divide the document into smaller sections and send the copy.

Frequently Asked Questions

<i>Message</i>	<i>Error Code</i>	<i>Cause</i>	<i>Action</i>
DOCUMENT READY	-	The document in the Automatic Document Feeder (ADF) is ready for scanning.	Send the fax, scan the document, or make a copy.
ECM RX	-	The FAX-L250 is receiving a fax using ECM.	Faxes can take longer to receive when using ECM. Try turning ECM off if you need to receive quickly, or if you know your local telephone lines are in good condition.
ECM TX	-	The FAX-L250 is sending a fax using ECM.	Faxes can take longer to send when using ECM. Try turning ECM off if you need to send quickly, or if you know your local telephone lines are in good condition.
HANG UP PHONE	-	The handset is off its hook.	Place the handset properly onto its hook.
LOAD PAPER	-	The FAX-L250 is out of recording paper.	Load paper in the sheet feeder. Any documents received in memory will then be printed automatically.
MEMORY FULL	#037	<p>The FAX-L250's memory is full because it has received too many documents, or a very long or detailed document.</p> <p>The memory is full because you sent too many pages at once, or a very long or detailed document.</p>	<p>Print out any documents that are stored in memory. Then start the operation again. See page 6-17.</p> <p>Divide the document and send each part separately. If the memory contains any faxes, you do not need to delete them.</p>

Error Codes, Messages, and Solutions

Message	Error Code	Cause	Action
MEMORY FULL PLEASE WAIT	-	The FAX-L250 is sending a fax and its memory is full.	Wait until the fax is sent. The FAX-L250 continues to send the fax as memory becomes available.
MEMORY USED nn%	-	Shows how much of the FAX-L250's memory is in use.	If you need more memory, print or send any documents stored in memory.
NO ANSWER	#005	The receiving fax machine does not answer.	Make sure you dialed the correct number. Try again later.
NO RX PAPER	#012	The other party's fax machine is out of paper and its memory is full.	Contact the other party and have them add paper to their fax machine.
NO TEL #	#022	The one-touch or coded speed dialling number has not been registered.	Register the number.
NOT AVAILABLE	-	In manual sending via the handset, you tried to use a one-touchspeed dialling button or a coded speed dialling code that has a group registered in it.	In manual sending via the handset, you cannot send a document to multiple destinations. Send the document to one destination at a time.
PLEASE WAIT	-	The FAX-L250 is warming up.	Wait until the time and receiving mode appear in the LCD display, then begin.
REC'D IN MEMORY	-	The paper or toner ran out, or a paper jam occurred, so the FAX-L250 received the document in memory.	Add paper to the sheet feeder, change the toner cartridge, or clear the paper jam, as needed. When the problem is solved, the FAX-L250 automatically prints the document stored in memory.

Frequently Asked Questions

<i>Message</i>	<i>Error Code</i>	<i>Cause</i>	<i>Action</i>
START AGAIN	-	An error occurred in the phone line or in the system.	Start the procedure over from the beginning.
TX/RX CANCELLED	-	You pressed the ⏹ (STOP) button to cancel the transmission.	-
TX/RX NO. nnnn	-	When the FAX-L250 sends or receives a fax, it assigns a unique identification number to it.	Write the number down if you will need it later. You can also print an activity management report after the transmission to check the TX/RX number if necessary.

11

Maintaining Your FAX-L250

Your FAX-L250 requires no maintenance other than periodic cleaning, and replacing of the toner cartridges as needed.

Cleaning the FAX-L250	11-2
Cleaning the FAX-L250 Exterior	11-2
Cleaning the Inside of the FAX-L250	11-3
Cleaning the Scanner Components	11-6
Replacing the Toner Cartridge	11-8
Transporting the FAX-L250	11-9

Cleaning the FAX-L250

Clean your FAX-L250 regularly to keep it in good operating condition.



Follow these precautions whenever you clean the FAX-L250:

- Before you begin cleaning the FAX-L250, be sure to print any faxes stored in its memory. See "Printing Documents Received in Memory" on page 6-17.
- Do not use tissue paper, paper towels, or similar materials for cleaning; they can stick to the components or generate static charges.

Cleaning the FAX-L250 Exterior

Clean the FAX-L250 outer casing as follows.

- 1** Disconnect the power cord from the FAX-L250.
- 2** Wipe the FAX-L250 exterior with a clean, soft, lint-free cloth moistened with water or diluted dishwashing detergent solution.



Never use thinner, benzene, alcohol, or any other organic solvent to clean the FAX-L250, as these can damage the FAX-L250's surface.

- 3** Plug the power cord back in.

Cleaning the Inside of the FAX-L250

To prevent toner powder and paper dust from accumulating and affecting the quality of the unit's printing, clean the inside of the FAX-L250 periodically as follows.



When you unplug the unit, any faxes stored in memory will be erased. Be sure to print out any documents stored in memory before unplugging the unit. See "Printing Documents Received in Memory" on page 6-17.

1 Unplug the FAX-L250.

2 Open the front cover by pressing the release latches on the sides of the unit.

- Lift the cover forward to its open position.

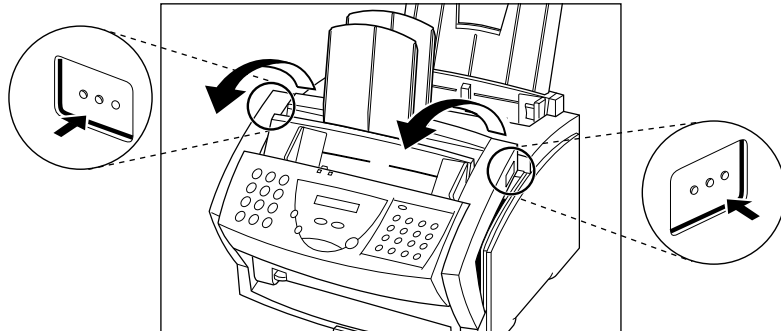

- 3** Hold the cartridge by its handle and remove it as shown.

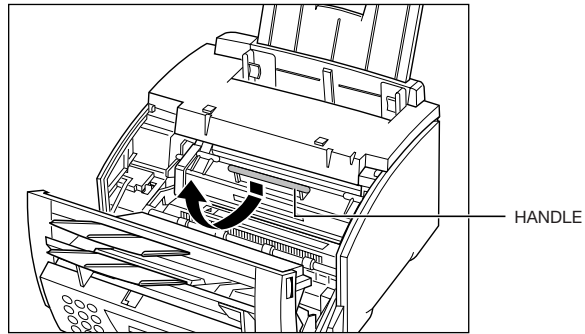

- Store the cartridge in its protective bag to avoid exposure to light.

- 4** Use a clean, soft, dry, lint-free cloth to remove any toner or paper debris from the shaded area.

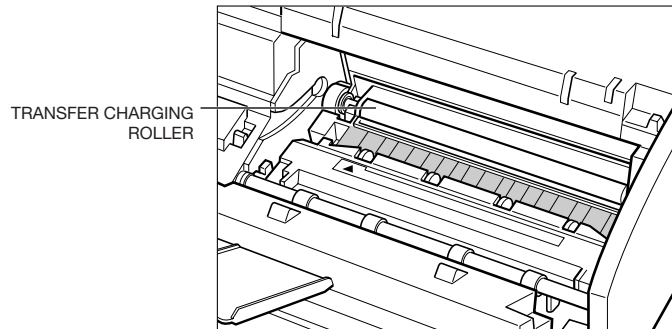

Do not touch the transfer charging roller at the back, as this may affect the print quality of the your faxes.

5 When you have finished cleaning the FAX-L250, replace the toner cartridge.

- Gently press the cartridge into the unit as far as it will go. Press down and back on the cartridge's handle.

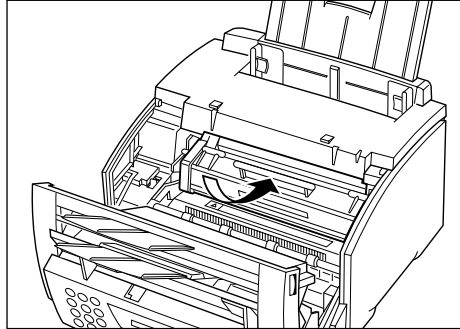

6 Close the front cover.

- Use both hands to lift the cover back into the closed position.

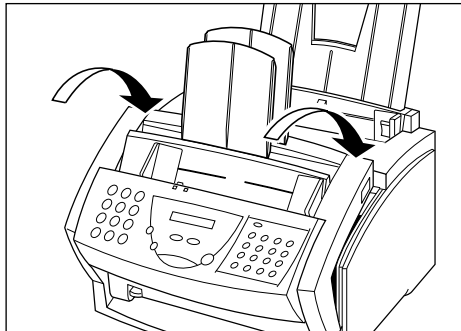

7 Plug the unit back in.

Cleaning the Scanner Components

Periodically check the scanning glass and rollers.



When you unplug the unit, any faxes stored in memory will be erased. Be sure to print out any documents received in memory before unplugging the unit. See "Printing Documents Received in Memory" on page 6-17.

1 Unplug the FAX-L250.

2 Open the operation panel.

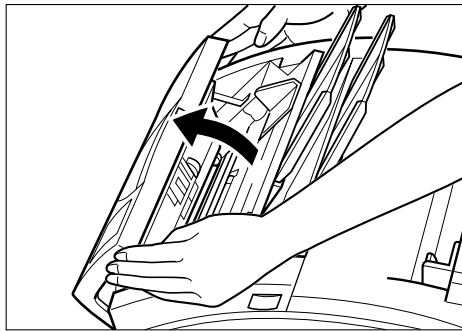

3 Use a soft, dry clean cloth to clean the scanning glass and rollers (shaded areas).

- If the document scanning glass and rollers are dirty, the documents you send or print will also be dirty.
- Clean with a soft cloth that will not scratch the glass or rollers.

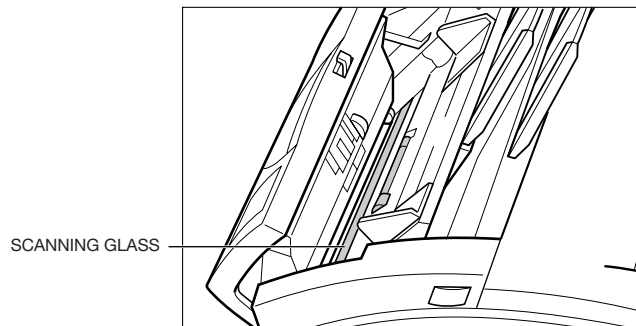

4 Clean the shaded areas of the operation panel and the unit.

- Dirt and dust particles that collect on the underside of the operation panel also affect the quality of documents you copy and send.

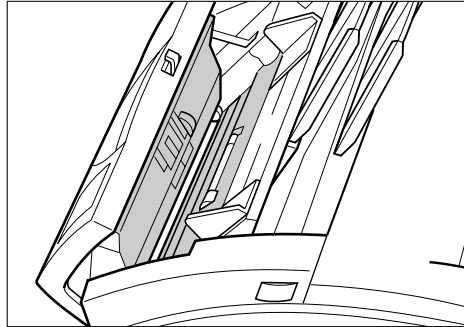

5 Use a soft, dry clean cloth to wipe up paper dust around the rollers.

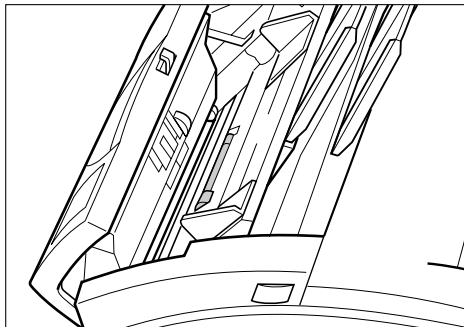

- 6** When you are finished, close the operation panel by pressing it down from the centre as shown.

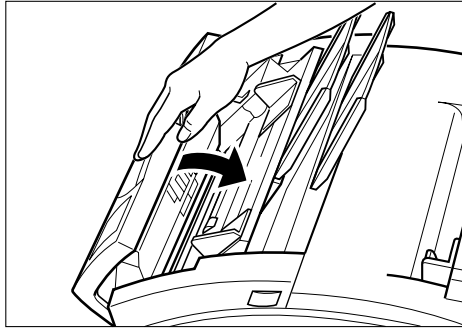

Be sure to close the operation panel until it locks into place. Otherwise the unit will not function properly.

-
- 7** Plug the FAX-L250 back in.

Replacing the Toner Cartridge

Each FX-3 toner cartridge contains enough toner to print approximately 2,700 pages of A4-size paper (about 4% paper coverage). The actual amount varies according to how much toner is used for each page.

If you cannot solve a print quality problem after following the steps in Chapter 10, "Frequently Asked Questions", you may need to replace the FX-3 toner cartridge.

For instructions on replacing the toner cartridge, see "The Toner Cartridge" in Chapter 2.

Transporting the FAX-L250

Whenever you plan to transport the FAX-L250, you need to prepare it so it will not be damaged during the move.

- 1** Unplug the unit from the wall outlet.
- 2** Remove any paper and/or documents from the unit.
- 3** Open the front cover by pressing the release latches on both sides of the unit and remove the toner cartridge.
 - Store the toner cartridge in its original protective bag or wrap it in a thick cloth to avoid exposure to light.
- 4** Use both hands to close the front cover until it clicks into position.
- 5** Disconnect the telephone or answering machine (if you have connected one to the unit).
- 6** Disconnect the power cord from the unit.
- 7** Remove the paper rest and support trays from the unit. See "Attaching Components" on page 2-11.
- 8** Replace all tapes and shipping materials you removed when you first unpacked the FAX-L250. See "Removing the Shipping Materials" on page 2-8.
- 9** Pack the FAX-L250 and all its components into its original shipping carton. Use the illustration on page 2-5 for reference.



If you no longer have the shipping carton your FAX-L250 came in, pack the unit in a suitably sized, sturdy cardboard box, using bubble wrap, foam peanuts, or other suitable packing materials.

This page is intentionally blank

12

The Menu System

This chapter summarises the FAX-L250 menu system. Use the information here as a guide to help you customise operations your unit performs.

Understanding the Menu System	12-2
Accessing the TEL REGISTRATION Menu	12-2
Accessing the USER SETTINGS Menu	12-4
Accessing the REPORT SETTINGS Menu	12-6
Accessing the TX SETTINGS Menu	12-8
Accessing the RX SETTINGS Menu	12-10
Accessing the FAX PRINTER Menu	12-12
Accessing the SYSTEM SETTINGS Menu	12-14







Understanding the Menu System

The FAX-L250 menu system allows you to customise the way your unit operates. The menu system consists of seven menus, each containing settings that control different functions of your FAX-L250. This chapter outlines the various menus and shows you how to use them.



The factory default settings in the following tables are shown in bold type.













Accessing the TEL REGISTRATION Menu

- 1** Press **FUNCTION**.
 
- 2** Use **<** or **>** to select **TEL REGISTRATION**.
 
- 3** Press **START/COPY**.
 
- 4** Use **<** or **>** to select the item you want to set or change.

TEL REGISTRATION

<i>Name</i>	<i>Description</i>	<i>Settings</i>
1-TOUCH SPD DIAL TELEPHONE NUMBER NAME	See page 4-3 "One-Touch Speed Dialling".	-
CODED SPEED DIAL TELEPHONE NUMBER NAME	See page 4-11 "Coded Speed Dialling".	-
GROUP DIAL TELEPHONE NUMBER NAME	See page 4-19 "Group Dialling".	-

Accessing the *USER SETTINGS* Menu

- 1** Press **FUNCTION**.
 
- 2** Use **< or >** to select **USER SETTINGS**.
  
- 3** Press **START/COPY**, then use **< or >** to select the item you want to set or change.
   
 - See the following table for a list of the items you can select.
- 4** Press **START/COPY**, then use **< or >** to select a setting or the sub-item you want to set or change.
 
 - See the following table for a list of the settings and sub-items you can select.
- 5** Press **START/COPY**.













USER SETTINGS

Name	Description	Settings
DATE & TIME	Set the date using the numeric buttons. Set the time (24-hour clock) using the numeric buttons.	–
UNIT TELEPHONE #	Enter your fax number using the numeric buttons. (Up to 20 digits.)	–
UNIT NAME	This is the name that appears at the top of each fax page you send. See page 3-10. (Up to 24 characters.)	–
TX TERMINAL ID	This option sets the parameters for the identification header that appears on every page you send. (TTI)	ON/OFF
TTI POSITION	Select the position of the TTI. OUTSIDE IMAGE : Position the TTI outside the image area. INSIDE IMAGE : Position the TTI inside the image area.	OUTSIDE IMAGE/INSIDE IMAGE
SCAN CONTRAST	Set the density of the reproduction. Set to DARKER for light originals and LIGHTER for dark originals.	DARKER/STANDARD/LIGHTER
OFFHOOK ALARM	Enable/disable the off hook alarm. The alarm alerts you that the handset is off its hook.	ON/OFF
VOLUME CONTROL	Set the audio level of the calling signal alarm and buttons on the operation panel.	–
CALLING VOLUME	Set the volume of the ring produced when the FAX-L250 detects a voice call during FAX/TEL switchover.	VOL MIN/VOL MID/VOL MAX
KEYPAD VOLUME	Set the volume of keypad touch beep	OFF/VOL MIN/VOL MID/VOL MAX
ALARM VOLUME	Set the volume of the error alarm sound.	OFF/VOL MIN/VOL MID/VOL MAX
LINE MONITOR VOL	Set the volume of the line monitor (sound during dialling).	OFF/VOL MIN/VOL MID/VOL MAX
RX CALL LEVEL	Adjust the volume of incoming calls.	STANDARD/HIGH
TEL LINE TYPE	Set the dialling method the FAX-L250 uses to match the type of phone line you have.	TOUCH TONE/ ROTARY PULSE*
R-KEY SETTING	Set the PBX type through which your unit is connected. See page 7-2 for more details.	PSTN/PBX
M-KEY SETTING (UK only)	Set an access and ID code for the 2300 service of Mercury Communications Limited. See page 7-9 for more details.	132, 131P

(Default settings are shown in bold type)

* The default setting for the UK and Singapore is **TOUCH TONE**.

Accessing the *REPORT SETTINGS* Menu











- 1** Press **FUNCTION**.
 
- 2** Use **<** or **>** to select **REPORT SETTINGS**.
  
- 3** Press **START/COPY**, then use **<** or **>** to select the item you want to set or change.
   
 - See the following table for a list of the items you can select.
- 4** Press **START/COPY**, then use **<** or **>** to select a setting or the sub-item you want to set or change.

 - See the following table for a list of the settings and sub-items you can select.
- 5** Press **START/COPY**.

REPORT SETTINGS

Name	Description	Settings
TX REPORT	Enable/disable automatic printing of the transmission report. PRINT ERROR ONLY prints the transmission report only when a transmission error occurs. OUTPUT YES prints the transmission report every time you send a document. OUTPUT NO turns off the transmission report feature.	PRINT ERROR ONLY / OUTPUT YES/ OUTPUT NO
TX CONFIRM REP.	If you choose OUTPUT YES or PRINT ERROR ONLY , set whether the first page of the fax also prints.	ON/OFF
RX REPORT	Enable/disable automatic printing of the reception report. PRINT ERROR ONLY prints the reception report only when an error occurs during reception. OUTPUT YES prints the reception report every time you receive a document. OUTPUT NO turns off the reception report feature.	PRINT ERROR ONLY/ OUTPUT YES/ OUTPUT NO

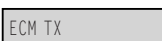
(Default settings are shown in bold type)

Accessing the TX SETTINGS Menu

- 1** Press **FUNCTION**.
 
- 2** Use **<** or **>** to select **TX SETTINGS**.
  
- 3** Press **START/COPY**, then use **<** or **>** to select the item you want to set or change.
   
 - See the following table for a list of the items you can select.
- 4** Press **START/COPY**, then use **<** or **>** to select a setting or the sub-item you want to set or change.

 - See the following table for a list of the settings and sub-items you can select.
- 5** Press **START/COPY**.

TX SETTINGS

Name	Description	Settings
ECM TX	Enable/disable error correction during transmission.	ON/OFF
MID PAUSE SET	Set the length of the pause you insert into a dialling sequence.	2 seconds (1 to 15)*
AUTO REDIAL	Set whether the FAX-L250 redials if it fails to get a response on the first attempt.	ON/OFF
REDIAL TIMES	Set the number of retries.	2 times (1 to 15)**
REDIAL INTERVAL	Set the period of time between rediallings.	2 minutes (2 to 99)***
TX ERROR RESEND	Set whether the fax redials if an error occurs while sending.	ON/OFF
RESEND TX FROM	Set which pages to resend if TX ERROR RESEND is on.	ERROR & 1ST PG/ ERROR PAGE/ALL PAGES
ERASE FAILED TX	Set whether the fax in memory is erased if an error occurs during sending but then it is resent successfully.	ON/OFF
AUTO START TX	ON-Scanning starts 10 seconds after the last number is entered when sending to multiple numbers (5 seconds if only sending to one location.) OFF-After entering the last number, press the ⏏ (START/COPY) button, or else the FAX-L250 will return to standby mode after 60 seconds.	ON/OFF











(Default settings are shown in bold type)

* UK and Hong Kong: 4 seconds (04-11)

** UK and Hong Kong: 01-03, Australia: 01-02, Ireland: 01-04, New Zealand: 01-05

*** Australia, Hong Kong, Malaysia: 01-99, New Zealand: 1 minute (01-99)

Accessing the RX SETTINGS Menu

- 1** Press **FUNCTION**.
 
- 2** Use **<** or **>** to select **RX SETTINGS**.
  
- 3** Press **START/COPY**, then use **<** or **>** to select the item you want to set or change.
   
 - See the following table for a list of the items you can select.
- 4** Press **START/COPY**, then use **<** or **>** to select a setting or the sub-item you want to set or change.

 - See the following table for a list of the settings and sub-items you can select.
- 5** Press **START/COPY**.

RX SETTINGS

Name	Description	Settings
ECM RX	Enable/disable error correction during reception.	ON/OFF
RX MODE	Set the receive mode. You can also set the receive mode with the RECEIVE MODE button. See Chapter 6 for more details. If you set Fax/Tel mode, you can select the options below. NET.SWITCH is only available for Australia and New Zealand.	FAX ONLY MODE/Fax/Tel Mode/MANUAL MODE/ANS. MACHINE MODE/NET. SWITCH*

If you have set Fax/Tel Mode, set the following options that control how the FAX-L250 handles incoming calls.

RING START TIME	Set the duration that the FAX-L250 listens for a fax tone before starting to ring.	8 seconds (00 to 30)
F/T RING TIME	Set the length of time the FAX-L250 will ring to alert you of an incoming call.	22 seconds (1 to 300)
F/T SWITCH ACTION	Select the action taken after the F/T RING TIME expires.	RECEIVE/DISCONNECT
INCOMING RING	When the FAX-L250 is set to FAX ONLY MODE, set the FAX-L250 to ring when it receives a call.**	ON/ OFF
RING COUNT	Set the number of incoming rings before the FAX-L250 answers.	2 times (1 to 99)***
ANS/FAX SWITCH	Enable/disable whether the FAX-L250 automatically switches to fax receive mode if a period of silence is detected after answering the call.	ON/ OFF
ANS/FAX SW TIME	Set the duration of silence the FAX-L250 listens for to determine if a fax is coming in.	6 seconds (1 to 99)
MAN/AUTO SWITCH	Determine if the FAX-L250 switches to document receive mode after the FAX-L250 rings for a specified time when the FAX-L250 is in MANUAL MODE.	ON/ OFF
RING TIME	Set the amount of time the FAX-L250 will ring before switching to document receive mode.	15 seconds (1 to 99)
REMOTE RX	Allows you to dial a number code on the remote extension to start receiving a document.	ON/ OFF
REMOTE RX ID	If you set REMOTE RX ON, you can change the remote receiving ID.	25 (00 to 99, * and # included)
MEMORY RX	Turn on/off memory receiving of a document.	ON/ OFF

(Default settings are shown in bold type)













* Set to NET. SWITCH when using the FaxStream DUET service (Australia only) or the FaxAbility service (New Zealand only).

** Even if you have set INCOMING RING to ON, the FAX-L250 will only ring if you have connected the optional handset or a telephone.

*** New Zealand: 01–05 times

Users in Ireland cannot set the RING COUNT item.

Accessing the FAX PRINTER Menu











- 1** Press **FUNCTION**.
 
- 2** Use **<** or **>** to select **FAX PRINTER**.
  
- 3** Press **START/COPY**, then use **<** or **>** to select the item you want to set or change.
   
 - See the following table for a list of the items you can select.
- 4** Press **START/COPY**, then use **<** or **>** to select a setting or the sub-item you want to set or change.
 
 - See the following table for a list of the settings and sub-items you can select.
- 5** Press **START/COPY**.

FAX PRINTER

Name	Description	Settings
PAPER SIZE	Select the size of the paper loaded in the sheet feeder.	A4/LTR/LGL
AUTO RX REDUCE	Reduce received faxes to fit on the recording paper.	ON/OFF
TONER SAVING	Enable/disable economy printing (toner saving feature). By enabling TONER SAVING, toner consumption can be decreased by as much as fifty percent, resulting in a longer effective cartridge life.	ON/OFF
TONER SUPPLY LOW	MEMORY RECEIVE enables receiving documents in memory when the toner level of the cartridge drops.	MEMORY RECEIVE/ AUTO PRINT

(Default settings are shown in bold type)

Accessing the **SYSTEM SETTINGS** Menu

- 1** Press **FUNCTION**.
 
- 2** Use **< or >** to select **SYSTEM SETTINGS**.
  
- 3** Press **START/COPY**, then use **< or >** to select the item you want to set or change.
   
 - See the following table for a list of the items you can select.
- 4** Press **START/COPY**, then use **< or >** to select a setting or the sub-item you want to set or change.

 - See the following table for a list of the settings and sub-items you can select.
- 5** Press **START/COPY**.

Accessing the SYSTEM SETTINGS Menu

SYSTEM SETTINGS

Name	Description	Settings
UN/LOCK PHONE	Set to restrict the ability to send documents or make calls. Does not restrict incoming calls/faxes. Once you register a password, you need to enter it before you can access the sub-items below.	
PASSWORD	Register a password to restrict access to the LOCK PHONE setting.	0000-9999
LOCK PHONE	Restrict or enable the ability to send documents or make calls.	ON/OFF
DATE FORMAT	Set the format used for dates displayed on the fax and printed on faxes you send.	DD/MM 'YY MM/DD/YY 'YY MM/DD
DISPLAY LANGUAGE	Set the language of the LCD messages.	ENGLISH/FRENCH/ SPANISH/ITALIAN/ FINNISH/GERMAN/ DANISH/SWEDISH/ DUTCH/NORWEGIAN/ PORTUGUESE/ SLOVENE/HUNGARIAN/ CZECH
TX START SPEED	Set the speed at which the FAX-L250 starts transmitting. Set this to a lower speed if you have difficulties connecting over long distance or noisy lines.	14400bps /9600bps/ 7200bps/4800bps
RX START SPEED	Set the speed at which the FAX-L250 starts receiving. Set this to a lower speed if you have difficulties connecting over long distance or noisy lines.	14400bps /9600bps/ 7200bps/4800bps

(Default settings are shown in bold type)

This page is intentionally blank.



Appendix A ***Specifications***

The specifications for the FAX-L250 are listed in this section.

General	A-2
Plain Paper Fax	A-4
Copier	A-6
Telephone	A-6
Document Sizes	A-7
Printing Area	A-8



General



- Applicable line:** Public Switched Telephone Network
- Compatibility:** G3
- Data compression system:** MH, MR, MMR (ECM-MMR)
- Modem type:** FAX modem
- Modem speed:** 14400, 12000, 9600, 7200, 4800, 2400 bps (automatic fallback)
- Transmission speed:** Approximately 6 seconds/page*
(transmitting from memory)
- Transmission/reception memory:**
- Approx. 1.4 MB DRAM, MR storage
 - Approximately 90 pages**
 - LCD displays memory used
 - Uses direct transmission when memory is full
- Liquid crystal display:** 16 × 1
- Display languages:** English, French, Spanish, Italian, Finnish, German, Danish, Swedish, Dutch, Norwegian, Portuguese, Slovene, Czech, and Hungarian
- Power source:** 200–240 V/50–60 Hz
- Power consumption:**
- Maximum: approximately 460 W
 - Minimum: approximately 8 W (Standby mode)
- Dimensions (W × D × H):** 365 × 365 × 242 mm
(main unit only, no trays, no optional handset)
- Weight:** Approximately 8.6 kg

* Based on Canon FAX Standard Chart No.1, ECM-MMR, standard mode

** Based on Canon FAX Standard Chart No.1, standard mode

- Environmental requirements:**
- Temperature: 10°–32.5°C
 - Humidity: 20%–85%RH

- Applicable standards:**
- Electrical safety: GS, FIMKO
 - Radiation: CISPR Pub22, Class B
 - PTT
 - Energy Star compliant



Plain Paper Fax



Automatic document feeder capacity:*

- 20 A4- or letter-size sheets
- 10 legal-size sheets

Manual document feeder capacity:*

- 1 sheet

Document sizes: (W × L)

Maximum
Automatic document feed: 216 × 355.9 mm
Manual document feed: 216 × Approx. 1 m

Minimum
Automatic document feed: 105 × 148 mm
Manual document feed: 88.9 × 44.5 mm

Document thickness:

- Automatic document feed:
0.07–0.13 mm
- Manual document feed:
0.06–0.3 mm

Document weight:

- Automatic document feed:
50–90 g/m²
- Manual document feed:
40–340 g/m²

Effective scanning width: 208 mm

Transmission time: Approx. 6 seconds** (G3 ECM MMR)

Resolution:

- Fine mode:
8 pels/mm × 7.7 lines/mm
- Standard mode:
8 pels/mm × 3.85 lines/mm

Scanning image processing:

- Ultra-High-Quality Image Processing System (UHQ™)
- Halftones: 64 levels of grey

* Based on 75 g/m² paper

** Based on Canon FAX Standard Chart No. 1, A4, standard mode.

Recording method: Laser Beam printing.

Recording paper sizes:

- A4 (210 × 297 mm)
- Letter (8.5 × 11 in.)
- Legal (8.5 × 14 in.)

Recording paper weight: 64–90 g/m²

Fax printing speed: Approx. 6 pages/minute*

Dialling:

- Automatic dialling:
 - One-touch speed dialling (16 locations)
 - Coded speed dialling (100 locations)
 - Group dialling (115 locations)
- Regular 10-button dialling (with numeric buttons)
- Automatic redialling (including error redialling)
- Manual redialling
- Pause button

Networking:

- Delayed transmission (up to 117 locations at a single pre-set time)
- Sequential broadcast (up to 117 locations)
- Automatic receiving
- Non-ring reception
- Deactivate ECM
- Net. Switch (Australia and New Zealand only)

Report/reference:

- Activity report (up to 20 transactions)
- Non-delivery report
- TTI (Transmitter Terminal Identification)

Toner saver: Economy mode for printing received faxes extends cartridge life to approx. 2,700 pages.

* Based on Canon FAX Standard Chart No. 1, A4, standard mode.



Copier



Scanning resolution:

- 600 × 300 dpi (Direct copy)
- 300 × 300 dpi (Memory copy)

Printing resolution: 600 × 600 dpi

Default size: 100%

Reduction sizes: 90%, 80%, 70%

Copy speed:

- Initial copy: 45 seconds
- Subsequent copies: 20 seconds

Multiple copies: Up to 99 copies of a document

Telephone



- Automatic FAX/TEL switchover
- Answering machine connection (CNG detecting signal, no sound)
- Telephone connection
- Optional handset connection
- Remote reception by telephone (Default reception ID: 25)
- Tone button
- Pause button
- Net. Switch (Australia and New Zealand only)

Document Sizes

The following illustrations show the largest and smallest documents you can feed into the FAX-L250.

When the document feed lever is set to Automatic document feed

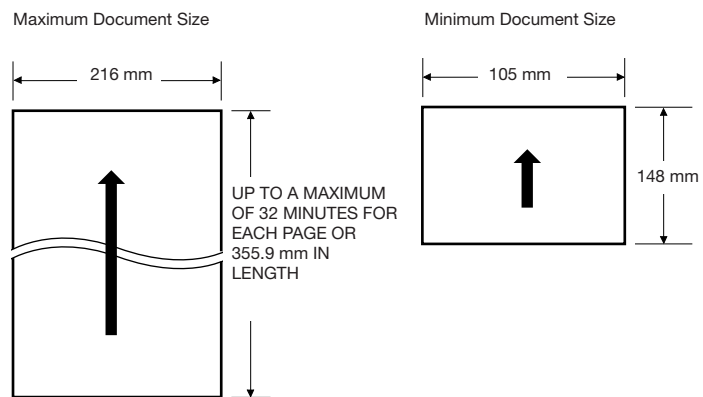

When the document feed lever is set to Manual document feed

Note that the scanning length may be shorter than the length of the actual document.

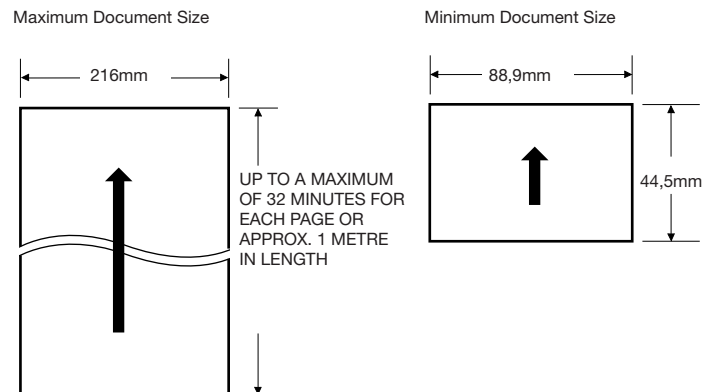

Appendix A – Specifications

The figure below shows how much of an A4-, letter-, or legal-size document the FAX-L250 scans when faxing or scanning.

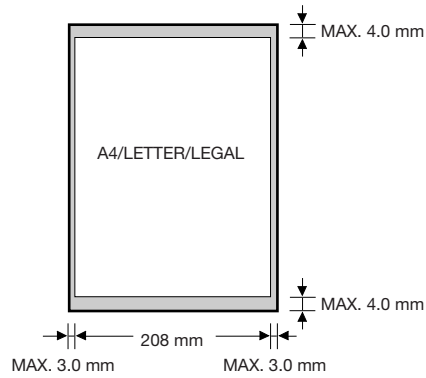

A margin of 3.0 mm on either side of the sheet and 4.0 mm on the top and bottom are outside the FAX-L250's scanning area.

Printing Area

Note that the unit cannot print completely from the edge of one border to another. The size of the margin differs slightly with the paper size.

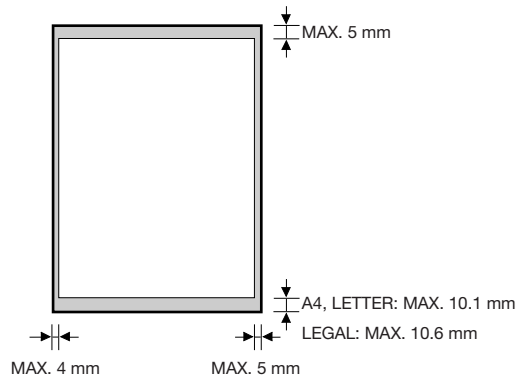



Appendix B

Options

This section describes the optional equipment available for use with the FAX-L250.

- Optional Handset B-2
- Package Contents B-2
- Attaching the Handset to Your Unit B-3
- Control Panel and Functions B-6
- Maintaining Your Handset B-8

Optional Handset

The optional handset is available for connection to your FAX-L250. Contact your Canon dealer for more information.

Package Contents

Make sure you have the following items. If anything is damaged or missing, notify your Canon dealer immediately.

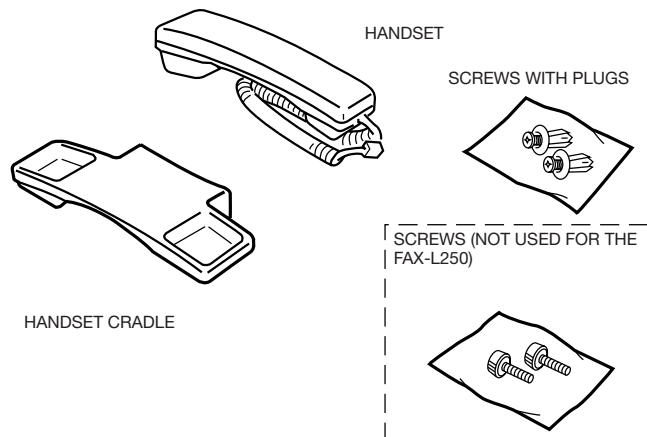

The two screws with a plastic white head are not for use with the FAX-L250. You only need the two screws with plugs provided.

Attaching the Handset to Your Unit

To attach the handset to your unit, follow these steps:

- 1** Use a screwdriver to remove the two covers on the left side of the unit.

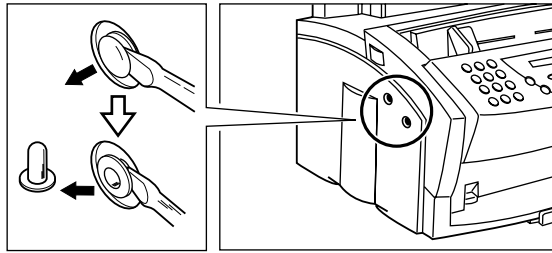

- 2** Remove the screws from the plugs and insert the plugs in the holes on the handset cradle.

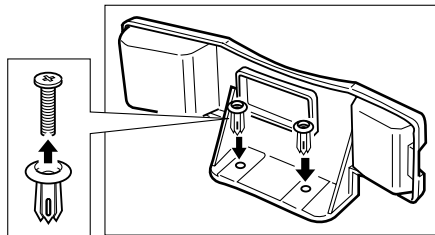

- 3** Insert the plugs with the handset cradle in the holes on the unit.



If you have difficulty inserting the plugs, turn the unit so that the left side is facing you and the right side is placed against a wall. This will allow you to insert the plugs without the unit moving.

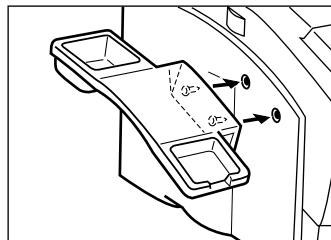

4 Insert the screws into the plugs and push them in with your finger.

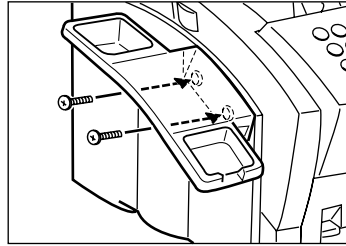

- If you cannot push the screws in with your finger, use a phillips screwdriver to push them in. (Do not screw them in as the screws may break.)
- Make sure the screws are inserted all the way into the plugs.

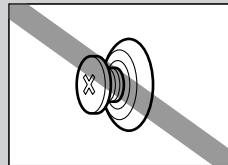
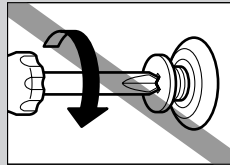

5 Connect the handset cord to the input jack marked  on the left side of the unit.

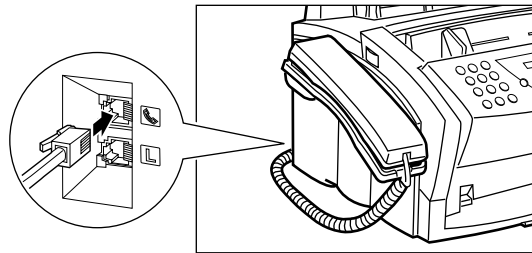



When carrying the unit, do not lift it by the handset cradle as it may break.

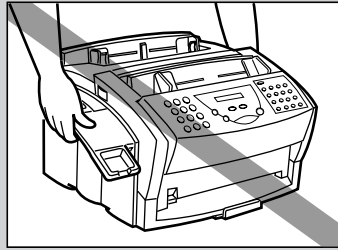

If you need to remove the handset cradle after it is installed, use a small phillips screwdriver to remove the two screws.

Control Panel and Functions

This section describes the parts of your handset and its functions.

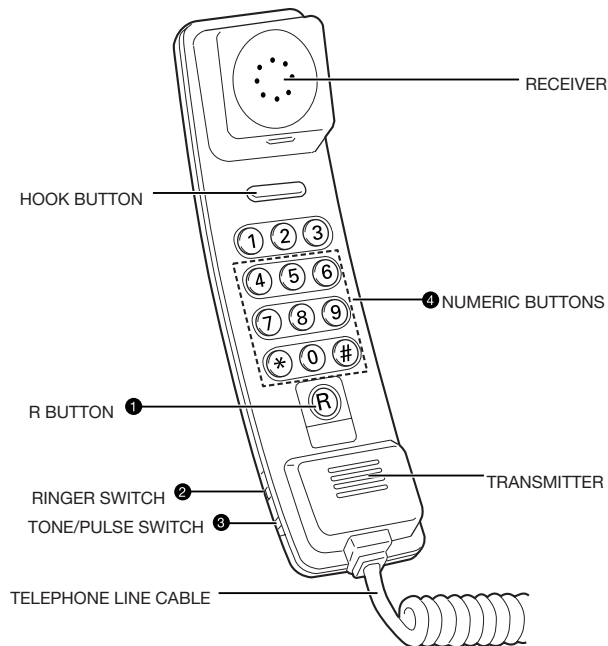

For details on the functions see the following pages.



Ringer Equivalence Number (R.E.N.) (UK only)

Your British Telecom line has a maximum R.E.N. capacity of 4. Your Canon unit has a R.E.N. value of 1 (unless otherwise stated), and this handset also has a R.E.N. value of 1. You can therefore use additional equipment with a total R.E.N. value of up to 2. If the R.E.N. value exceeds 4, the ringer volume will be reduced and one or more of the connected equipment may not function.

① R Button

This button can be used when the handset is connected to a PABX or a System 'X' exchange. The R button is used to obtain a second line to the PABX while holding the original line (for example, when transferring a call from one extension to another or when using some of the new features of the System 'X' exchange*). See your PABX user guide, or contact your service provider** for details. See also page 7-2 of this user's guide.

② Ringer Switch

The ringer switch allows you to select the ring volume of the handset for incoming calls. Set to HI, LO, or OFF according to your preference.

③ Tone/Pulse Switch

The handset is designed to operate on both Multi-Frequency (Tone) and Loop Disconnect (Pulse) telephone lines.

The Tone/Pulse switch enables you to switch from tone dialling to pulse dialling or vice versa. Contact your service provider** for further information.

Use a pointed instrument to set this switch to P (pulse dialling) or T (tone dialling).

④ Numeric Buttons

Use the numeric buttons to dial the number of the party you wish to call.

*** Button**

Press this button to enter a pause between numbers. (For pulse dialling only.)

Button

Press this button to redial the last number you called. (For pulse dialling only.)

* System 'X' exchange features include B.T. STAR SERVICES (UK only), THREE WAY CALLING, and CALL WAITING.

**UK only: Service providers are either British Telecom, Kingston Upon Hull City Council, Mercury Communications or your PABX supplier or maintainer.

Maintaining Your Handset

Follow these guidelines to maintain your handset in top working condition.

- Do not leave your handset exposed to direct sunlight.
- Do not install your handset in hot or humid conditions.
- Do not spray aerosol polishes on your handset as they may enter the holes on your handset and cause damage.
- Use a damp cloth to clean your handset.

Glossary

A

AC

Alternating current. The type of electrical current available from a wall outlet.

Activity report

A journal of the FAX-L250's fax transactions, both sent and received.

Auto FAX/TEL switching

See *FAX/TEL switching*.

Automatic dialling

Dialling fax or telephone numbers by pressing one or three buttons. To use automatic dialling, you must register the numbers in the FAX-L250's memory. See also *One-touch speed dialling*, *Coded speed dialling*, and *Group dialling*.

Automatic Document Feeder (ADF)

The device included in the FAX-L250 that feeds the document being faxed, copied, or scanned into the FAX-L250.

Automatic image reduction

The FAX-L250 can print the date, time, company name, and a fax number at the top of the faxes it receives. To prevent this information from crowding the faxed image on the page and possibly lengthening the fax, the FAX-L250 automatically reduces the size of the image on the page.

Automatic redialling

When the receiving fax machine is busy or does not answer, or when an error occurs while sending, the FAX-L250 waits a specified time and then automatically redials the number. If the receiving fax is still busy or does not answer, the FAX-L250 waits the specified time and dials again. If the fax still doesn't go through, the FAX-L250 prints an activity report.

B

bps

Bits per second. Refers to the speed with which a fax machine sends and receives data.

Broadcasting

Transmitting documents to more than one location (through the FAX-L250's memory).

C

CCITT/ITU-T

Formerly known as CCITT, Consultative Committee for International Telegraph and Telephone. CCITT has been replaced by the International Telecommunications Union-Telecommunications sector (ITU-T), a committee created to set international standards for telecommunications.

CNG

Calling Tone. This is a signal sent by fax machines to identify the call as an incoming document. When the receiving fax detects this signal, it automatically starts to receive the fax transmission. The majority of fax machines in use today can send and detect CNG signals.

Coded speed dialling

An automatic dialling method that allows you to dial a fax or telephone number by pressing the **CODED DIAL** button and a two-digit code using the numeric buttons.

Cursor

The underline symbol you see on the LCD display when you register numbers and names in the FAX-L250. Press the < or > button to move the cursor.

D

dB (A)

Stands for decibel level (a decibel being a unit of measurement for the intensity of the sound coming from the unit), adjusted for background noise.

Delayed sending

The ability to send a document at a preset time in the future. You do not have to be in your office to use delayed sending to one or more destinations. (You can set up only one delayed transmission at a time on the FAX-L250.)

Dialling methods

Ways of pressing one or more buttons to access a number to connect to an outside party or fax machine. Dialling methods include one-touch, coded speed dialling, group dialling, and regular dialling with the numeric buttons.

Document

The sheet of paper containing the data that you send to, or receive from a unit.



Glossary

dpi

Dots per inch. A unit of measurement for indicating a unit's resolution. Your FAX-L250 produces a resolution of 600 dpi.

Dual access (Multitasking)

Enables the FAX-L250 to receive a fax, even if it is copying or printing a document. Also enables you to load other faxes into memory, make copies, print out reports, print documents or register information while the FAX-L250 sends a fax from memory.

E

ECM

Error Correction Mode. The ability of your FAX-L250 to reduce system and line errors when sending or receiving from another fax with ECM capability. ECM is most effective in areas where the telephone lines are in poor condition or there is frequent interference on the line. Do not use ECM if you need to send a document quickly and you are sure the other party can read your transmission without it (turning off ECM also turns off MMR).

Extension

A telephone connected to the FAX-L250 that is used in place of the handset. You can use the extension telephone to activate incoming reception of documents manually.

F

Factory default

The FAX-L250 is preprogrammed in the factory with settings that we recommend. These are known as Factory Default Settings. You can customise your FAX-L250 by programming settings other than the Factory Default Settings.

FAX/TEL switching

This option allows you to set the FAX-L250 to automatically detect whether a call is from a fax or telephone. If the call is from another fax, the transmission is automatically received. If the call is from a telephone, the FAX-L250 rings to let you know, so you can pick up the handset. With this feature, one telephone line can be shared by both the telephone and the fax.

FINE

The resolution setting for documents with very small characters and lines.

G

G3, Group 3 fax machine

Defined by CCITT. Uses encoding schemes to transmit image data while reducing the amount of data that needs to be transmitted, thus reducing transmission time. G3 fax machines can transmit one page in less than one minute. Encoding schemes for G3 fax machines are Modified Huffman (MH), Modified READ (MR), and Modified Modified READ (MMR).

Group dialling

A dialling method that enables you to dial up to 115 registered one-touch speed dialling or coded speed dialling numbers together as a group. This means that you can press just one or three buttons to enter numbers when sending the same document to many destinations.

H

Halftone

Using this method, the FAX-L250 produces shades of grey by mapping dots to be printed.

J

Jack

The telephone receptacles on your wall or on your FAX-L250 used to connect the FAX-L250 to the telephone line, answering machine, optional handset, or telephone.

M

Manual receiving

A method of receiving faxes in which you answer all incoming calls using the handset. If you hear a slow beep it indicates an incoming fax transmission from another machine. Just press the Φ (START/COPY) button to receive the incoming fax.

Manual redialling

When you use Regular dialling, you can redial a number manually simply by pressing the **REDIAL/PAUSE** button on the the operation panel. The last number called is the number redialled.

Memory broadcast

Allows you to send a scanned fax to as many as 117 locations at once, using a combination of one-touch speed dialling, coded speed dialling, or regular dialling.



Glossary

Memory sending

Scans a document into memory before the FAX-L250 dials the numbers and sends it. This method allows you to retrieve your original document immediately after scanning.

N

Noise

A term applied to a variety of problems that impair the operation of telephone lines used for faxing.

Noise level

See *dB (A)*.

Numeric buttons

The round, numbered buttons on the operation panel marked the same as a standard telephone keypad. Press them to perform regular dialling. You also use the numeric buttons to enter numbers and letters when you register numbers and names, and for entering coded speed dialling codes.

O

One-touch speed dialling

An automatic dialling method that allows you to dial a fax or telephone number by pressing a single one-touch speed dialling button. The FAX-L250 can store up to 16 numbers for one-touch speed dialling.

One-touch speed dialling buttons

The buttons numbered 1 to 16 on the operation panel, each of which may be registered as a fax or telephone number. Once a number is registered, you press one button to dial the entire number.

P

Paper feed

Refers to guiding a sheet of paper into the unit's paper path.

Pause

A timing entry required for registering certain long distance numbers and for dialling out through some telephone systems or switchboards. Pressing the **REDIAL/PAUSE** button enters a pause between digits of a telephone number.

Photo

The document setting you use for sending or copying documents with intermediate tones, such as photographs.

Polling

One fax machine requesting another to send a document. The receiving party calls the fax machine holding the document to be sent, and requests that it be sent.

Pulse

See *Rotary pulse*.

Q

Quick-on-line sending

Quick-on-line sending is the easiest and quickest way to send a document. After a document is set in the Automatic Document Feeder (ADF), the FAX-L250 begins to scan the entire document into the memory. As the first page of a multi-page document is being scanned, your FAX-L250 will begin to call the other party, and transmit the information even as the remaining pages are being scanned. The FAX-L250 scans the document quickly so you can get it back in a few moments and return to work.

R

RECEIVE MODE

The button that controls how the FAX-L250 receives fax and telephone calls.

Receiving

Receiving transmission is also defined as RX or Reception. The FAX-L250 can be customised to receive fax documents in many ways:

- Receive fax documents only (**FAX ONLY MODE**)
- Receive both telephone calls and fax documents on the same line (**Fax/Tel Mode**)
- Receive telephone calls and fax documents manually (**MANUAL MODE**)

Reception

See *Receiving*.

Redialling-automatic

When the fax you dial does not answer or a sending error occurs, the FAX-L250 waits for a specified interval and then redials the same fax number. You can adjust the number of redials and the length of time between redialling.

Redialling-manual

When you use the regular dialling method, you can quickly call the last number dialled by pressing the **REDIAL/PAUSE** button.



Glossary

Reduction mode

The FAX-L250's automatic feature that slightly reduces the received image to allow room at the top of the page for the sender's ID information. You can also reduce the size of large incoming documents using the AUTO RX REDUCE option.

Registering

A process by which you place fax or telephone numbers and names in the FAX-L250's memory for automatic dialling so that you can save time dialling frequently called destinations.

Regular dialling

Pressing the individual numeric buttons to dial a fax or telephone number.

Remote receiving ID

The two-digit code that enables you to manually activate a fax using a telephone that is connected to the FAX-L250.

Remote reception

Activating a fax by answering a telephone that is connected to the FAX-L250, but that is not located near the FAX-L250. You need to dial a remote receiving ID number to start remote reception.

Report

A document printed by the FAX-L250 and containing information about the faxes it has sent or received.

Resolution

The density of dots for any given output device. Expressed in terms of dots per inch (dpi). Low resolution causes font characters and graphics to have a jagged appearance. Higher resolution means smoother curves and angles as well as a better match to traditional typeface designs. Resolution values are represented by horizontal data and vertical data, for example, 360 × 360 dpi. This unit produces output with 600 × 600 dpi precision.

Rotary pulse

A telephone dialling system where a dial is rotated to send pulses to the telephone switching system. When you pulse dial, you hear clicks. When you touch-tone dial, the most common dialling system, you hear tones. Rotary pulse dialling requires certain setting adjustments.

RX

See *Receiving*.

S

Scanning contrast

A setting that darkens or lightens the scanning of documents.

Sender ID

Information printed at the top of a fax (also called TTI or Transmit Terminal ID):

- Date and time the fax was sent
- Sender's fax/phone number
- Sender's name
- Your name or company name
- Page number

Sending

A fax document that has been scanned by a facsimile machine and sent over telephone lines, in the form of electrical pulses, to another facsimile machine. Also called TX or Transmit.

Sending speed

The rate at which faxes are transmitted through the phone line. See also *bps (bits per seconds)*.

STANDARD

A document setting for sending normal typewritten or printed documents containing only text and no drawings, photographs, or illustrations.

Standby

The mode in which the FAX-L250 is on and ready to use. All operations start from standby mode when the LCD displays the time and receiving mode.

T

Timed sending

See *Delayed sending*.

Tone/pulse setting

The ability to set the FAX-L250 to match the telephone dialling system your telephone line uses: touch-tone or rotary pulse.

TONE

A button that allows you to temporarily switch to touch-tone from pulse dialling. In some countries, on-line data services may require that you use tone dialling.



Glossary

Toner

A black, resin coated powder contained in the FX-3 toner cartridge. The unit applies the toner to the surface of the photosensitive drum inside the unit via an electrophotographic mechanism.

Toner saver

You can enable or disable economy printing (toner saving feature) when receiving faxes. By enabling the TONER SAVING mode, toner consumption can be decreased by as much as fifty percent, resulting in a longer effective cartridge life.

Transaction number

A unique number assigned to each fax document sent (TX NO.) or received (RX NO.) by the FAX-L250 and used to identify that particular fax document.

Transmit

See *Sending*.

TTI

Transmit Terminal ID. See *Sender ID*.

TX

See *Sending*.

U**UHQ™ Ultra High Quality)**

An exclusive Canon digital image processing system that incorporates 64 shades of grey along with a special edge enhancement feature which ensures that text and photos are transmitted with ultimate clarity.

Index

A

- ADF** *see* *Automatic Document Feeder (ADF)*
- ALARM lamp**
 - explanation 2-21
- alternative telephone networks 7-9 to 7-13**
 - registering 7-10
 - sending with 7-12
- answering machine**
 - connecting 2-15
 - using 6-11
- ANS.MACHINE MODE**
 - description 6-2
 - selecting 6-3
 - using 6-11
- arrow buttons**
 - explanation 2-24
- assembling 2-11**
- attaching**
 - paper loading label 2-12
 - paper rest 2-11
 - support trays 2-13
- Australia**
 - FaxStream DUET 6-12
 - network FAX/TEL switching 6-12
- AUTO REDIAL message 10-30**
- automatic**
 - redialling 5-24
- automatic document feed 5-3**
 - loading documents 5-7
 - selecting 5-6
- Automatic Document Feeder (ADF) 2-18**
 - Adding pages 5-20
 - jams 10-5 to 10-7
 - removing document 5-22
- automatic redialling 5-24 to 5-28**
 - cancelling 5-25
 - setting up 5-26

B

- B.T. adaptor 2-15**
- broadcasting**
 - sequential 5-29
- BUSY/NO SIGNAL message 10-30**

C

- CALLING message 10-30**

- cancelling**
 - automatic redialling 5-25
 - manual redialling 5-24
 - receiving 6-18
 - sending 5-21
- cartridge seetoner cartridge**
- CHANGE CARTRIDGE message 6-16, 10-30, 10-31**
- CHECK COVER/CART message 6-16, 10-31**
- CHECK DOCUMENT message 10-31**
- CHECK PAPER SIZE message 10-31**
- CHECK PRINTER message 10-31**
- cleaning**
 - exterior 11-2
 - inside of unit 11-3 to 11-5
 - scanner components 11-6 to 11-7
- CLEAR PAPER JAM message 6-17, 10-31**
- CODED DIAL button**
 - explanation 2-22
- coded speed dialling**
 - changing names 4-14
 - changing numbers 4-14
 - description 4-2
 - list 9-11
 - storing numbers 4-11
 - using 4-17
- COMMUNICATING PLEASE WAIT message 10-31**
- components 2-18 to 2-24**
- connecting**
 - answering machine 2-15
 - optional handset 2-15
 - power cord 2-16
 - telephone 2-15
 - telephone line 2-14
- contrast**
 - DARKER 5-14
 - LIGHTER 5-14
 - setting 5-14
 - STANDARD 5-14
- conventions**
 - type 1-7
- copying 8-2 to 8-4**
 - problems 10-26
 - receiving while 6-17
 - resolution 8-2
- customer support 1-8**

D

- delayed sending 5-32 to 5-34**
 - sending during 5-34
- DELAYED TX button**
 - explanation 2-23
- deleting**
 - document in memory 5-37
- dial tone**
 - confirming 7-5
- dialling**
 - coded speed 4-11 to 4-18, 5-15
 - group 4-19 to 4-23
 - long distance 7-4
 - methods 5-15
 - one-touch speed 4-3 to 4-10, 5-15
 - regular 5-15
 - special 7-2
 - through switchboard 7-2
- dimensions 2-4**
- DOC TOO LONG message 10-31, 10-32**
- document**
 - identifying your 3-8
 - in memory 5-35 to 5-39, 6-16
 - requirements 5-3
 - scanning area 5-5
- document feed**
 - automatic 5-3, 5-6
 - manual 5-3, 5-6
- document feed lever**
 - explanation 2-21
- DOCUMENT READY message 10-32**
- D.T. button**
 - explanation 2-24
 - using 7-5

E

- ECM (Error Correction Mode) 1-4**
- ECM RX message 10-32**
- ECM TX message 10-32**
- editing**
 - information 3-5
- entering**
 - date 3-9
 - guidelines 3-2
 - letters 3-3
 - numbers 3-3
 - symbols 3-3
 - time 3-9

Index

error
codes 10-30 to 10-34
resending after 5-38
connecting 2-15

F

FAX ONLY MODE
description 6-2
selecting 6-3, 6-10

FAX PRINTER
accessing 12-12
description 3-7
settings 12-13

Fax/Tel Mode
description 6-2
selecting 6-3
setting 6-4 to 6-8

features
copier 1-5
main 1-3
plain paper fax 1-4
telephone 1-5

feeding paper
problems 10-18 to 10-19

FUNCTION button
explanation 2-23

G

group dialling
creating groups 4-19
description 4-2
list 9-11
sending 5-31
using 4-22

H

handset 2-20
connecting 2-15

HANG UP PHONE message
10-32

J

jams
after cleaning 10-17
in Automatic Document Feeder (ADF) 10-5 to 10-7
in front area 10-14 to 10-16
in output slots 10-8

inside unit 10-9 to 10-13
paper 10-5 to 10-17

L

LCD display
explanation 2-21

list
coded speed dial 9-11
documents in memory 5-35
group dial 9-11
one-touch speed dial 9-11
speed dialling 9-10 to 9-11
user's data 9-8 to 9-9

LOAD PAPER message 6-17, 10-32

loading 2-33 to 2-35
recording paper documents 5-7 to 5-12

location
choosing 2-3
dimensions 2-4

long distance
dialling 7-4

M

M button 7-12, 7-13

M label 2-6
attaching 7-9

manual
redialling 5-24
sending via the handset 5-15, 5-16

manual document feed 5-3
loading documents 5-11
selecting 5-6

MANUAL MODE
description 6-2
selecting 6-3
using 6-9, 6-10

memory
deleting documents from 5-37
documents in 5-35 to 5-39
list of documents in 5-35
printing documents in 6-17
resending 5-38

MEMORY FULL message 10-32

MEMORY FULL PLEASE WAIT message 10-33

MEMORY REF button
explanation 2-23

memory sending 5-15, 5-18

MEMORY USED nn% message 10-33

menu system
FAX PRINTER 3-7, 2-12 to 12-13
REPORT SETTINGS 3-7 12-6 to 12-6
RX SETTINGS 3-7, 12-10 to 12-11
SYSTEM SETTINGS 3-7, 12-14 to 12-15
TEL REGISTRATION 3-6, 12-2 to 12-13
TX SETTINGS 3-7, 12-8 to 12-9
understanding 12-2
USER SETTINGS 3-6, 12-4 to 12-5
using 3-6, 3-7

messages 6-16, 10-30 to 10-34

multitasking 1-3

N

Network FAX/TEL switching
Australia 6-12
New Zealand 6-14

New Zealand
FaxAbility 6-14
network FAX/TEL switching 6-4

NO ANSWER message 10-33

NO RX PAPER message 10-33

NO TEL # message 10-33

NOT AVAILABLE NOW message 10-33

numeric buttons
explanation 2-22

O

one-touch speed dial buttons
explanation 2-22
using 3-6

one-touch speed dialling
changing names 4-6
changing numbers 4-6
description 4-2
list 9-11
storing numbers 4-3
using 4-9

operation panel 2-21

Index

P

- paper**
 - jams 10-5 to 10-17
 - recording 2-33
- paper delivery**
 - face-down delivery 2-39
 - face-up delivery 2-40
 - paper path 2-37
 - selecting 2-38
 - selector 2-18, 2-39, 2-40
- password/subaddress**
 - sending with 5-40 to 5-42
- pause**
 - entering 7-4
- PBX 7-2**
- PLEASE WAIT message 10-22**
- polling 6-19**
- power cord**
 - connecting 2-16
- power cut 5-43**
- print quality**
 - problems 10-28
- printing**
 - documents in memory 6-17
 - list of documents in memory 5-35
 - problems 10-27
 - receiving while 6-17
- problems**
 - copying 10-26
 - faxing 10-20 to 10-25
 - feeding paper in sheet feeder 10-18 to 10-19
 - general 10-29
 - index 10-3 to 10-4
 - printing 10-27
 - printing quality 10-28
 - receiving faxes 10-22 to 10-25
 - sending faxes 10-20 to 10-22
 - telephone 10-26
 - unable to solve 10-2
- pulse line**
 - setting 3-12
 - using tone dialling on a 7-6
- PWD/SUBADD button**
 - explanation 2-23**

R

- R button**
 - explanation 2-24
 - registering 7-2 to 7-3

- REC'D IN MEMORY message 10-33**
- receive mode**
 - setting 6-3
- RECEIVE MODE button**
 - explanation 2-22
 - using 6-3
- receiving**
 - ANS.MACHINE MODE 6-2, 6-3, 6-11
 - cancelling 6-18
 - FAX ONLY MODE 6-2, 6-3, 6-10
 - Fax/Tel Mode 6-2, 6-3, 6-4 to 6-8
 - in memory 6-16
 - MANUAL MODE 6-2, 6-3, 6-9, 6-10
 - methods 6-2
 - mode 6-3
 - problems 10-22 to 10-25
 - while copying 6-17
 - while printing 6-17
 - while registering 6-17
- recording paper**
 - loading 2-33
- REDIAL/PAUSE button**
 - explanation 2-21
- redialling 5-24 to 5-28**
 - automatic 5-24
 - cancelling 5-24, 5-25
 - manual 5-24
- replaceable parts 2-10**
- replacing cartridge 2-27, 11-8**
- report 9-2 to 9-7**
 - activity 9-2
 - transmission (TX) 9-3 to 9-5
 - error TX 9-3
 - TX 9-4 to 9-5
 - reception (RX) 9-6
 - memory clear 9-7
- REPORT button**
 - explanation 2-33
- REPORT SETTINGS**
 - accessing 12-6
 - description 3-7
 - settings 12-7
- registering**
 - fax number 3-10
 - name 3-10
 - R button 7-2 to 7-3
 - receiving while 6-17
- resolution**
 - copying 8-2
 - setting 5-13

RESOLUTION button

- explanation 2-22
- FINE 5-13
- PHOTO 5-13
- STANDARD 5-13
- using 5-13
- restricting**
 - making calls 7-7 to 7-8
 - sending 7-7 to 7-8
- RX SETTINGS**
 - accessing 12-10
 - description 3-7
 - settings 12-11

S

- safety instructions 1-9 to 1-11**
- scanning area 5-5**
- sending**
 - manual via the handset 5-15, 5-16
 - memory 5-15, 5-18
 - preparing to send 5-3
 - problems 10-20 to 10-22
- sequential broadcasting 5-29**
- setting**
 - cancelling 5-21
 - delayed 5-32
 - documents 5-16
 - group dialling 5-31
 - manual via the handset 5-15, 5-16
 - memory 5-15, 5-18
 - methods 5-15
 - password/subaddress 5-40 to 5-42
 - resending 5-38
 - sequential broadcast 5-29
 - telephone line type 3-12
- setting**
 - contrast 5-14
 - resolution 5-13
- sheet feeder 2-18**
 - problems feeding into 10-18
- shipping materials**
 - removing 2-8, 2-9
- special function buttons**
 - explanation 2-22
 - FUNCTION button 2-23
 - DELAYED TX button 2-23
 - PWD/SUBADD button 2-23
 - MEMORY REF button 2-23
 - REPORT button 2-23
 - D.T. button 2-24
 - TONE/+ button



Index

arrow buttons 2-24
R button 2-24
using 3-6

speed dialling
coded 4-2, 4-11 to 4-18
group dialling 4-2, 4-19 to
4-23, 5-31
lists 9-10 to 9-11
methods 4-2
one-touch 4-2, 4-3 to 4-10

START AGAIN message 10-34

START/COPY button
explanation 2-22

STOP button
explanation 2-22

switchboard
dialling through 7-2

SYSTEM SETTINGS
accessing 12-14
description 3-7
setting 12-15

T

TEL REGISTRATION
description 3-6
accessing 12-2
settings 12-3

telephone

connecting 2-15
problems 10-26

telephone line
connecting 2-14
setting type 3-12

testing
unit 2-36

PHONE/+ button
explanation 2-24
using 7-6

toner cartridge
handling 2-25
storing 2-25
installing 2-27
replacing 2-27, 11-8

touch tone
setting 3-12
using on a pulse line 7-6

TX SETTINGS
description 3-7
accessing 12-8
settings 12-9

**TX/RX CANCELLED message
10-34**

**TX/RX NO. nnnn message
10-34**

transporting unit 11-9

U

**UHQ™ (Ultra High Quality)
1-4**

UK 5-13
alternative telephone
networks 7-9 to 7-13
B.T. adaptor 2-15
M label 2-6, 7-9

unit
cleaning 11-2 to 11-7
components 2-18 to 2-24
lifting 2-7
paper path 2-37
personalising 3-8
testing 2-36
transporting 11-9

unpacking 2-5

USER SETTINGS
accessing 12-4
description 3-6
settings 12-5

user's guide
using 1-6

V

Ventilation 1-9, 2-3

